













Self-contained ice maker - Paddle system Daily production up to 56 kg

| | |
|---------------|------------|
| Hotel | ██████████ |
| Restaurant | ██████████ |
| Fast food | ██████████ |
| Bar | ██████████ |
| Disco | ██████████ |
| Fish market | ██████████ |
| Supermarket | ██████████ |
| Medical & SPA | ██████████ |
| Industry | ██████████ |

► Position n°



► Features & Plus

- Hollow cube 
- AISI 304 SS Scotch Brite finish 
- Tropical class +43°C 
- Adjustable Stainless Steel feet
- Removable and cleanable air filter 
- Air or water cooling system
- Easy cleanable internal rounded surfaces 
- HCFC-Free insulated storage 
- FDA approved -ABS water basin 
- Basin tipping safety system
- RoHS Free 
- Disappearing insulated door 
- Electromechanical operation
- ON-OFF rocker switch
- Automatic water charge
- Standard and special voltages
- HFC Free 



AISI 304 SS Scotch Brite finish



Removable and cleanable air filter



FDA approved - ABS water basin



Disappearing insulated door

► Available ice cube size

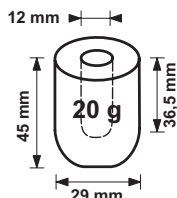

► Prod. 24h

| °C | Air temp. | | Water temp. | | kg | lbs |
|----|-----------|-------|-------------|-------|----|-----|
| | 10° C | 50° F | 7° C | 45° F | | |
| | 21° C | 70° F | 15° C | 60° F | | |
| | | | | | 56 | 123 |
| | | | | | 46 | 101 |

2 Years Warranty
subject to limitations

► Certifications available for this model





Ice Finger

IMF 58 HC



Self-contained ice maker - Paddle system
Daily production up to 56 kg

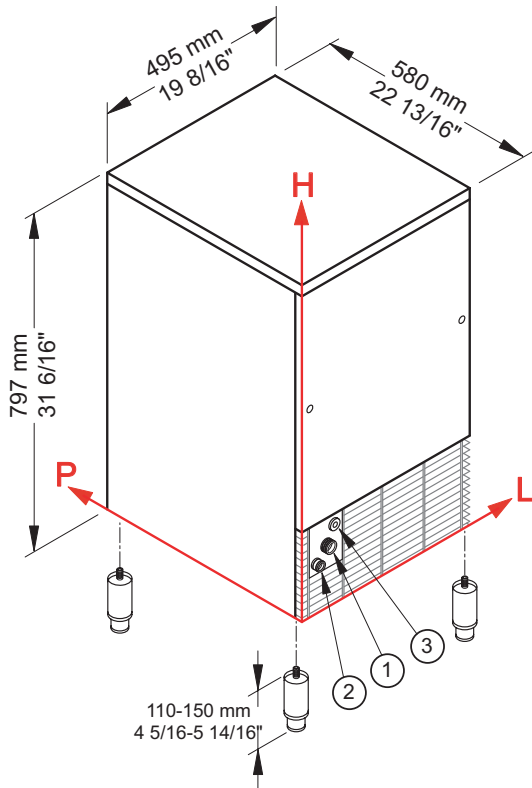

► Working conditions

- Location: **Indoor**

| | Min | Max |
|----------------------|-----------------|-----------------|
| Ambient temperature | +10° C / +50° F | +43° C / 110° F |
| Water temperature | +3° C / +37° F | +32° C / +90° F |
| Voltage | -10% | +10% |
| Water inlet pressure | 1bar (14 psi) | 6bar (84 psi) |

► Performances

| | Air temperature | Water temperature | Water temperature | | | | | |
|--|-----------------|-------------------|-------------------|---------|-------|-------|--------|-------|
| | | | 7° C | 45° F | 15° C | 60° F | 21° C | 70° F |
| | 10° C | 56 kg | | | | | | |
| | 50° F | 123 lbs | | | | | | |
| | 21° C | | | 46 kg | | | | |
| | 70° F | | | 101 lbs | | | | |
| | 32° C | | | | | 34 kg | | |
| | 90° F | | | | | | 75 lbs | |

► Connections

All measures are referred to the rear bottom-left corner (L-H-Ø)

- ① Water in.: 111 mm / 4 6/16" - 196 mm / 7 11/16" - 3/4" ② Water out.: 49 mm / 1 15/16" - 151 mm / 5 15/16" - 24 mm / 15/16"
③ Electrical connections: 156 mm / 6 2/16" - 232 mm / 9 2/16"

► Technical information

| | | | |
|---------------------------|-------------------|----------------------------|----------------------------------------|
| Production in 24h | 46 kg / 101 lbs | Water consumption | A: 4 l/kg - 48 gal/100 lbs |
| Store capacity, up to | 20 kg / 44 lbs | | W: 13 l/kg - 156 gal/100 lbs |
| Cooling system | A - W | Sizes (L-P-H mm) | 495 - 580 - 797 |
| Kind of cube | A-20g | (L-P-H in) | 19 8/16 - 22 13/16 - 31 6/16 |
| Refrigerant | R290 | Sizes with pack (L-P-H mm) | 550 - 630 - 990 |
| Standard voltage | 220-240 V ~ 50 Hz | (L-P-H in) | 21 10/16 - 24 13/16 - 39 |
| Average power consumption | 315 W | Net weight | 54 kg / 119 lbs |
| Fuse | 10 A | Gross weight | 62 kg / 137 lbs |
| Electrical consumption | 21 kWh/100kg | Finish | AISI 304 stainless steel, scotch brite |

All the technical information must be considered at the following conditions:

- Sizes without feet
- Standard Cube (20 g)
- Ambient temperature +21° C
- Water temperature +15° C
- Electrical consumption at +32° C (standard voltage)
- Average power consumption at +43° C (standard voltage)

Models and specifications are subject to change without notice

Rev. 00 - Issued March 2021



www.bremaice.it
info@bremaicegroup.it

We are Brema

