



SPARE PARTS TAVOLA RICAMBI

TR12SQ0

SPEC.	N.	CODE	DENOMINAZIONE - DENOMINATION	PRICE
Assembly 400V 50-60Hz 3Ph		SA1108	ROTOR - ROTORE	€ 47.00
	* 1	SL4069	Pusher - Pestello	€ 2.10
	2	SL0136	Hopper - Tramoggia	€ 18.00
	3	SL0140	Shaft - Albero	€ 9.00
∅25x∅40x7	4	SL0139	Oil seal - Paraolio	€ 2.50
6203 2RS	5	SL0131	Bearing - Cuscinetto	€ 6.00
	* 6	SL0138	Knob - Pomello	€ 3.50
	* 7	SL2917	Cap - Tappo	€ 1.61
	8	SL3980	Sleeve - Bocchettone	€ 30.50
∅40	9	SL0132	Seeger - Seeger	€ 0.50
	10	SL0130	Gear - Ingranaggio	€ 19.00
Assembly	11	SA3710	Sleeve - Bocchettone	€ 51.00
	12	SL0125	Gear - Ingranaggio	€ 23.00
	13	SL0124	Shaft - Albero	€ 3.50
400V/3Ph/50Hz	14	SA1014	Stator - Statore	€ 98.00
230V/1Ph/50Hz	14	SA1015	Stator - Statore	€ 103.00
	15	SL0128	Gear - Ingranaggio	€ 12.00
∅17x∅40x7	16	SL0127	Oil seal - Paraolio	€ 2.00
	18	SL0186	Calotte - Calotta	€ 16.00
	19	SL2833	Cover - Coperchio	€ 2.00
1Ph+N+Gnd	20	SL1671	Electric cable - Cavo elettrico	€ 6.50
3Ph+Gnd	20	SL1841	Electric cable - Cavo elettrico	€ 12.00
PG11	21	SL1668	Cable clamp - Pressacavo	€ 1.00
Stainless-steel	22	SL0142	Sleeve - Bocchettone	€ 52.80
Food stuff treated steel CE	22	SL3078	Sleeve - Bocchettone	€ 23.00
Food stuff treated steel NO CE	22	SL4156	HUB - BOCCHETTONE	
Aluminium CE	22	SL4333	HUB - BOCCHETTONE	€ 24.70
Stainless-steel	* 23	SA5300	Screw shaft - Elica	€ 41.00
Aluminium	* 23	SA5312	Screw shaft - Elica	€ 36.00
	24	SL2521	Pivot - Perno	€ 10.50
	* 25	////////	Cutter - Coltello	
	* 26	////////	Cutter - Coltello	
Stainless-steel	27	SL0171	Handwheel - Volantino	€ 24.00
Aluminium	27	SL3327R0	Handwheel - Volantino	€ 12.00
	28	SL0180	Container - Recipiente	€ 9.80
TR12SQ0	29	SL2566	Base - Base	€ 25.00
TR12B	29	SL3244	Base - Base	€ 27.00
TR12SQ0 Start-stop	* 30	SL0891	Push button - Pulsante	€ 15.00
TR12B Start-stop + relay 250v	* 30	SL2919	Push button - Pulsante	€ 9.50
16µF	31	SL0177	Condenser - Condensatore	€ 4.50

*Ricambio consigliato - Advised spare parts

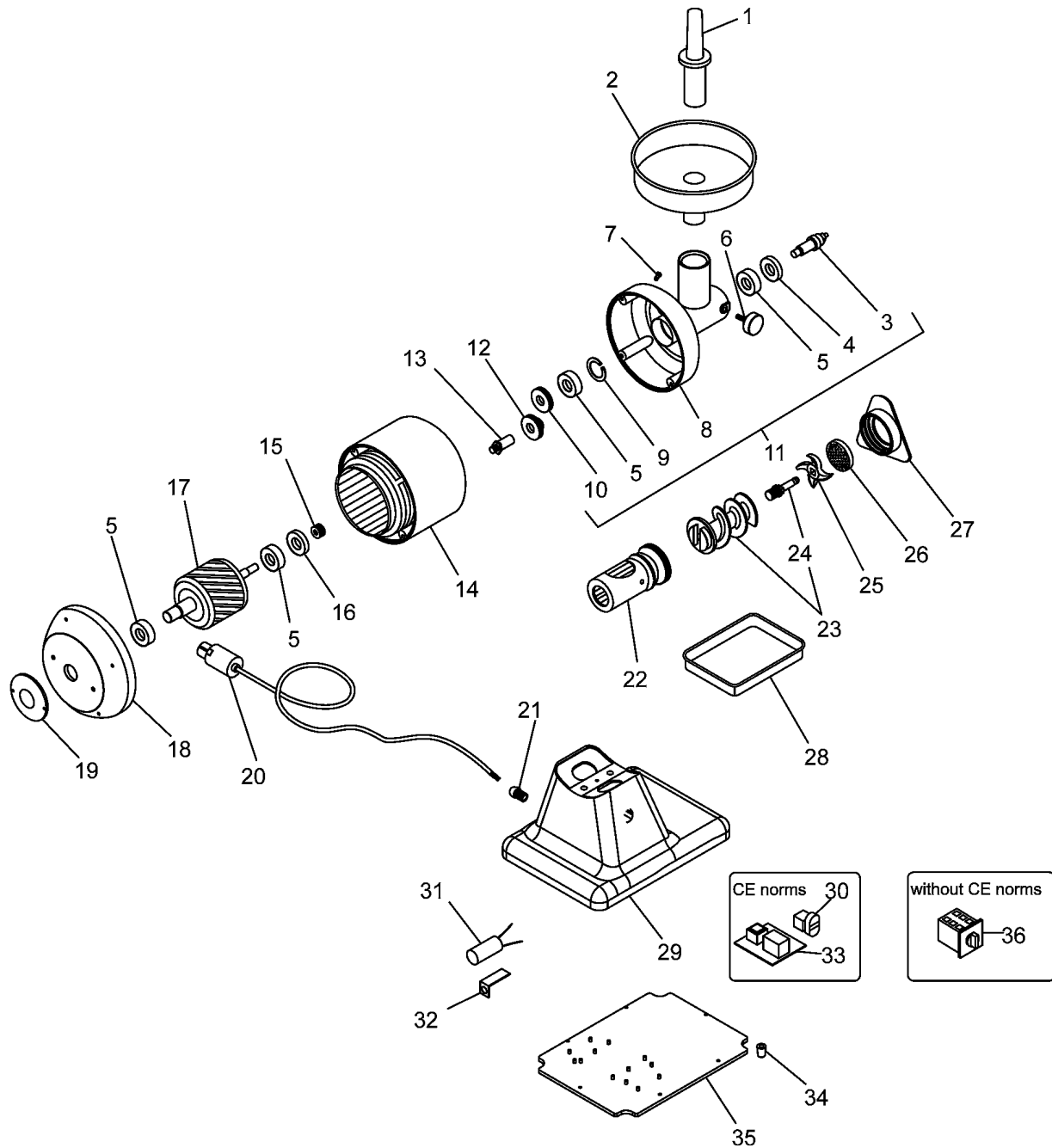

POS. CODE

	SA1108
1	SL4069
2	SL0136
3	SL0140
4	SL0139
5	SL0131
6	SL0138
7	SL2917
8	SL3980
9	SL0132
10	SL0130
11	SA3710
12	SL0125
13	SL0124
14	SA1014
14	SA1015
15	SL0128
16	SL0127
18	SL0186
19	SL2833
20	SL1671
20	SL1841
21	SL1668
22	SL0142
22	SL3078
22	SL4156
22	SL4333
23	SA5300
23	SA5312
24	SL2521
25	//////////
26	//////////
27	SL0171
27	SL3327R0
28	SL0180
29	SL2566
29	SL3244
30	SL0891
30	SL2919
31	SL0177



SPARE PARTS
TAVOLA RICAMBI

TR12SQ0

SPEC.	N.	CODE	DENOMINAZIONE - DENOMINATION	PRICE
	32	SL0176	Bracket - Staffa	€ 1.50
110V fino al 26/10/2014	* 33	SA1135	Electronic card - Scheda elettronica	€ 35.00
230/400V	* 33	SL0883	Electronic card - Scheda elettronica	€ 40.25
110V dal 27/10/2014	* 33	SL0902	Electronic card - Scheda elettronica	€ 32.00
	34	SL0235	Foot - Piedino	€ 1.00
	35	SL2651	Bottom - Fondo	€ 4.50
	36	SL0054	Switch - Interruttore	€ 17.35
Assembly 230V 50Hz 1Ph	42	SA1104	ROTOR - ROTORE	€ 56.00

*Ricambio consigliato - Advised spare parts

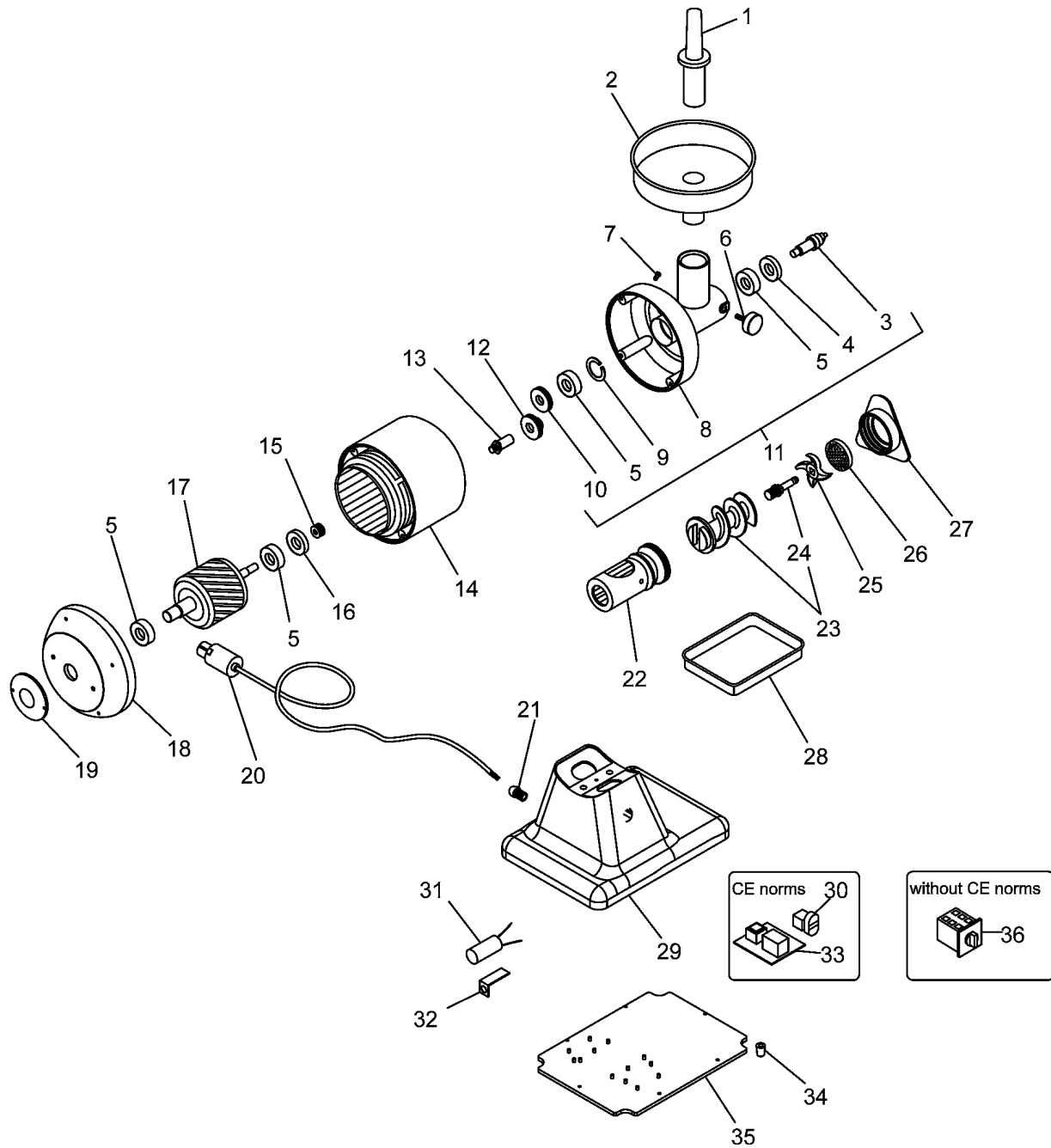

POS. CODE

32	SL0176
33	SA1135
33	SL0883
33	SL0902
34	SL0235
35	SL2651
36	SL0054
42	SA1104