

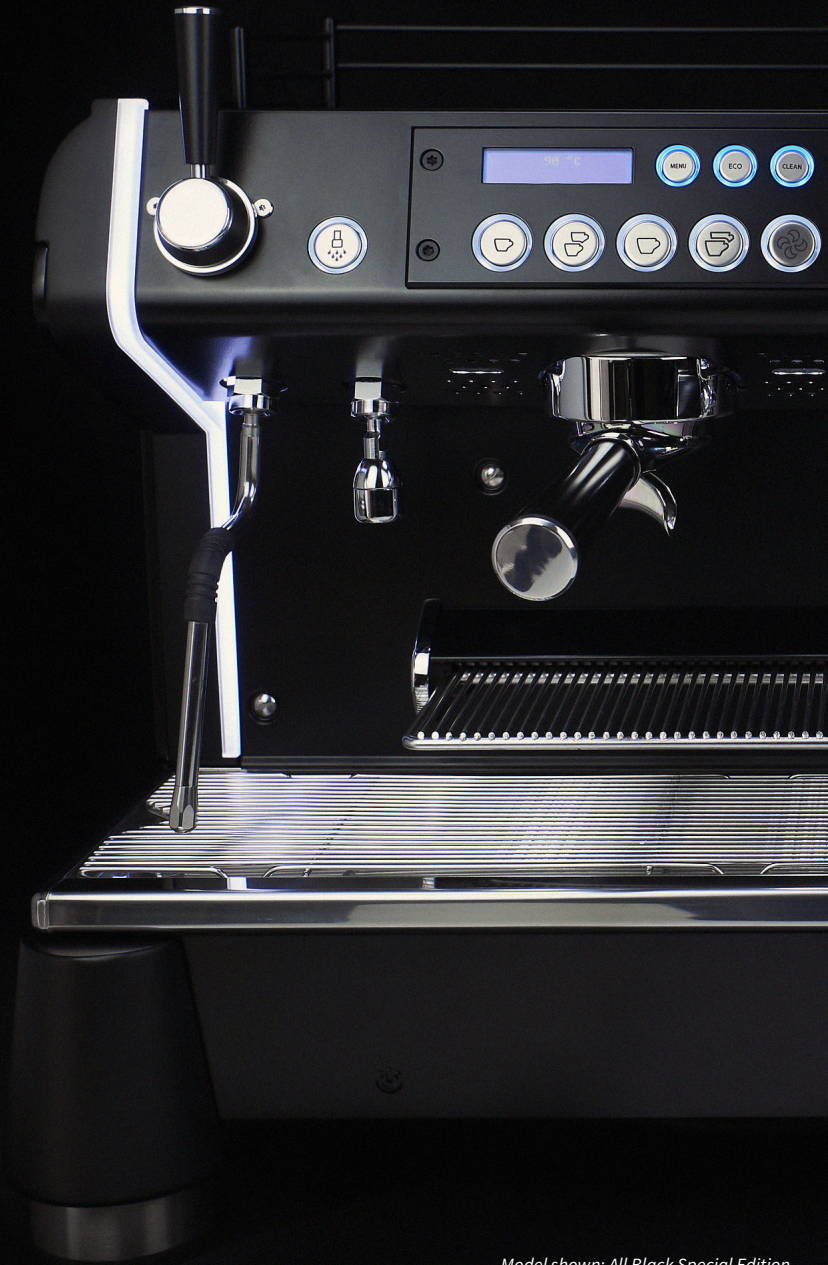

Monte Carlo

PRECISE,
STYLISH &
INTUITIVE



Model shown: All Black Special Edition



Nestled quietly within the heart of Monaco is our small, but perfectly formed factory, hand-crafting espresso machines since 1956. We combine a genuine passion for innovation and coffee excellence, with exceptional quality and reliability to produce the finest machines for any circumstance or environment.

www.conti-espresso.co.uk

ESTD 1956

Conti
MONACO



Monte Carlo



The Monte Carlo is a culmination of over 60 years of research and design. Created to meet the needs of baristas and roasters worldwide, the Conti Monte Carlo combines good looks, endless power, and extreme precision.

Conceived for the most discerning, Barista, Roaster or any serious operator, the Monte Carlo has a harmonious combination of style, practicality, precision build quality and advanced technology to ensure it is a future proof consideration for any outlet.



Multi Boiler, Triple Heat Zone System

Each coffee boiler and coffee group, are accurately temperature controlled by their own PID system and supplied with preheated water from our unique heat exchange system, the Monte Carlo ensures perfect precision for your coffee every time. Each group acts independently, thus allowing the user to offer perfect brew temperatures for coffees of different origin or roast profile, with these settings accessed quickly and easily via the intuitive touchpad menus.



Soft Pre-Infusion

Intended to replicate the simplistic but ultimately effective one-way pre-infusion found on the originally lever style espresso machine, our in-house system ensures that the barista can fully saturate the coffee puck under controlled low pressure. This results in incredibly consistent extraction, reduction in channelling and espresso with increased body and better mouthfeel.



Accumetrix

Our own, in-house volumetric system enables the machine to accurately read the volume of brewed espresso in the cup. This removes the need to weigh every extraction, improving workflow and consistency. Designed to detect resistance in flowrate, the software accurately responds to the flowmeter and displays exact shot volume on independent touchpad screens above each coffee group. The adjustable interface means it can show details of each extraction, including shot time, volumetrics, and flowrate.

Additional Features:

Cool touch steam wands

Enable the barista to work more safely by eliminating steam burns, whilst also ensuring the best possible hygiene levels thanks to the non-stick low temperature surface.

Conti Excellium non stick coated portafilters

This non-stick treatment helps prevent build of coffee oils which can taint espresso flavour.

Multi-Level User Interface

With an independent group interface and full diagnostic touchscreen, the Monte Carlo can be finely tuned to suit any environment. Simply decide your settings, then lockdown the touchscreen to avoid any accidental changes.

Barista Comforts

From barista lights, retractable cup stands and auto clean modes, through to the separate ECO modes for each coffee group, the Monte Carlo has been designed with feedback from baristas around the globe.

Precision

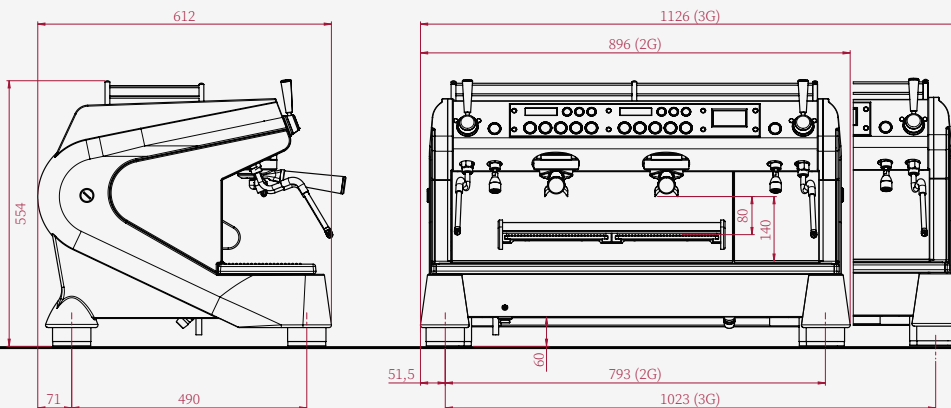

Competition standard Shower Plates and Baskets – Machined and packaged exclusively for Conti by IMS, these components have exacting build criteria to ensure an even extraction. The exacting hole diameter and polished inner surface perforations, help avoid any obstruction during the brewing process, meaning a more consistent homogenous shot every time.



	2 Group	3 Group
Height (mm)	554	554
Width (mm)	896	1126
Depth (mm)	612	612
Weight (kg)	86	103
Steam Boiler Size (Litres)	10	14
Coffee Boiler Size (Litres)	0.9 x 2	0.9 x 3
Group Element (W)	100	100
Steam Boiler Element (W)	4200/6000	6000
Coffee Boiler Element (W)	1000/2500	1000/2500
Total Power (W)	1900-6700/3000-11500*	2600-9600/3000-14100*
Voltage (V)	400 (230 option)	400

*Please note total power can be adjusted within power management.

Colour Options:

-  Matt Jet Black
-  Matt Traffic White
-  Custom RAL



Special Editions:

-  All Black
-  Wood Finish



Conti UK
Email: info@conti-esspresso.co.uk
Tel: 01763 249 398
www.conti-esspresso.co.uk

Unit 12-13 Wyndmere Park,
Ashwell Road,
Steeple Morden, Royston
Hertfordshire SG8 0NZ

 @contiespresso
 conti-esspresso uk