



LISTA RICAMBI ZOE 1-2-3 GR

Cod.83002001—09/2016



TAV / DRAW 1.....	PANNELLI / PANELS.....	Pag.3
TAV / DRAW 2.....	LANCIA VAPORE / STEAM PIPE.....	Pag.11
TAV / DRAW 3.....	CALDAIA / BOILER.....	Pag.14
TAV / DRAW 4-5.....	IMPIANTO IDRAULICO / HYDRAULIC SYSTEM.....	Pag.17
TAV / DRAW 6.....	GRUPPO EROGAZIONE /DISTRIBUTION GROUP	Pag.23
TAV / DRAW 7.....	CARICO SCARICO ACQUA / WATER CHARGE-DISCHARGE.....	Pag.25
TAV / DRAW 8.....	IMPIANTO ELETTRICO / ELECTRICAL SYSTEM.....	Pag.28



TAVOLA
DRAWING

PANNELLI / PANELS



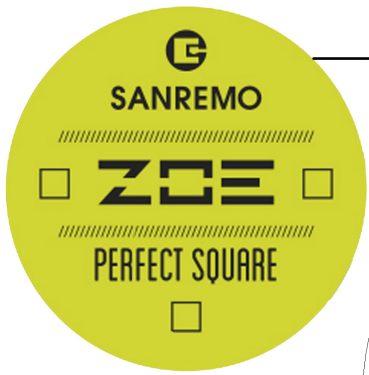
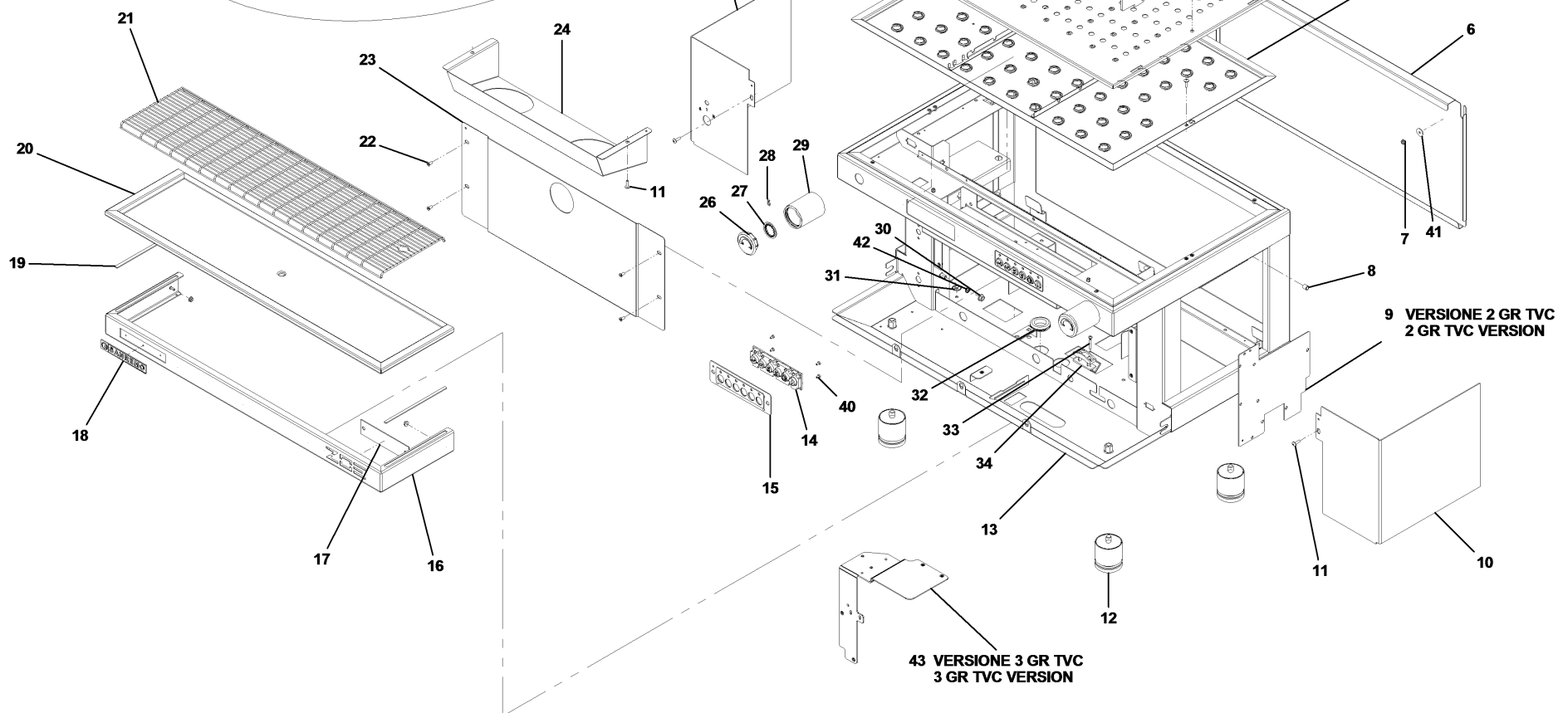
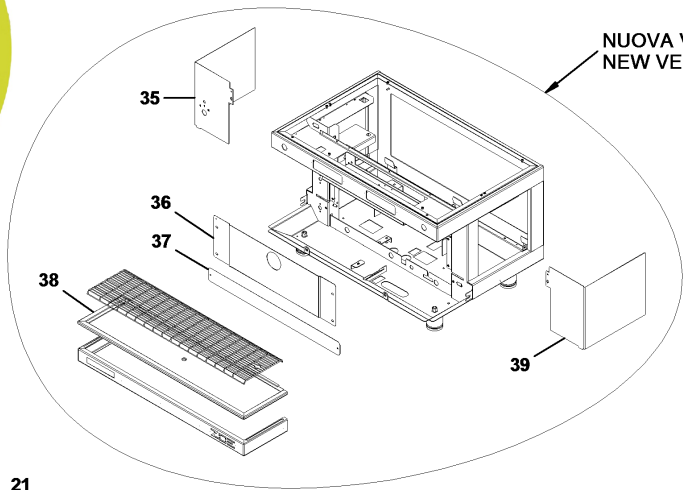
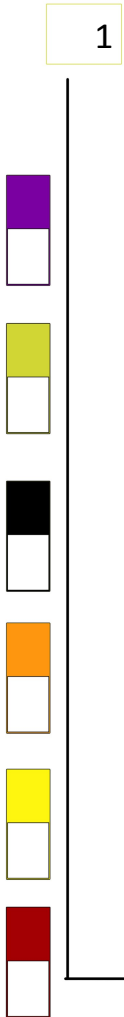

TAVOLA
DRAWING

1

PANNELLI / PANELS

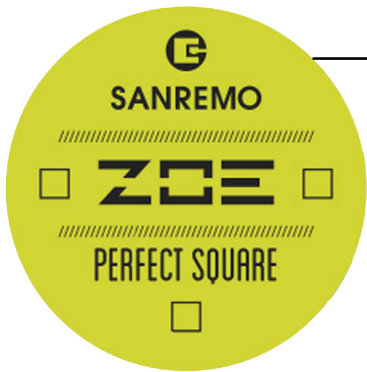
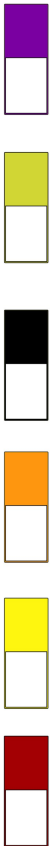

RIF. POS	CODICE CODE	DESCRIZIONE	DESCRIPTION	NOTE NOTES
1	10805022A	VITE TBL M4X20 A2	TBL SCREW M4X20 A2	
2A	10352428	FERMATAZZE ZOE 1 GR TRASPARENTE	CUP SUPORT ZOE 1 GR TRANSPARENT	1GRUPPO/1GROUPS
2B	10352430	FERMATAZZE ZOE 2 GR TRASPARENTE	CUP SUPORT ZOE 2 GR TRANSPARENT	2GRUPPO/2GROUPS
2C	10352432	FERMATAZZE ZOE 3 GR TRASPARENTE	CUP SUPORT ZOE 3 GR TRANSPARENT	3GRUPPO/3GROUPS
3	10955013A	ETICHETTA "SUPERFICIE CALDA"	"HOT SURFACE" LABEL	
4A	10017626	GRIGLIA POGGIA TAZZE ZOE 1 GR	CUP HOLDER GRID ZOE 1GR	1GRUPPO/1GROUP
4B	10017326	GRIGLIA POGGIA TAZZE ZOE 2 GR	CUP HOLDER GRID ZOE 2GR	2GRUPPI/2GROUPS
4C	10017526	GRIGLIA POGGIA TAZZE ZOE 3 GR	CUP HOLDER GRID ZOE 3GR	3GRUPPI/3GROUPS
5A	10017624	VASCA SUPERIORE ZOE 1GR	UPPER TANK ZOE 1 GR	1GRUPPO/1GROUP
5B	10017324	VASCA SUPERIORE ZOE 2GR	UPPER TANK ZOE 2 GR	2GRUPPI/2GROUPS
5C	10017524	VASCA SUPERIORE ZOE 3GR	UPPER TANK ZOE 3 GR	3GRUPPI/3GROUPS
6A	10017632	PANNELLO POSTERIORE ZOE 1 GR NERO LUCIDO	REAR PANEL ZOE 1 GR GLOSSY BLACK	1GRUPPO/1GROUP
6B	10017634	PANNELLO POSTERIORE ZOE 1 GR ROSSO	REAR PANEL ZOE 1 GR RED	1GRUPPO/1GROUP
6C	10017636A	PANNELLO POSTERIORE ZOE 1 GR VIOLA	REAR PANEL ZOE 1 GR VIOLET	1GRUPPO/1GROUP
6D	10017638	PANNELLO POSTERIORE ZOE 1 GR NERO OPACO	REAR PANEL ZOE 1 GR MATT BLACK	1GRUPPO/1GROUP
6E	10017642	PANNELLO POSTERIORE ZOE 1 GR GIALLO*	REAR PANEL ZOE 1 GR YELLOW	1GRUPPO/1GROUP
6F	10017332	PANNELLO POSTERIORE ZOE 2 GR NERO LUCIDO	REAR PANEL ZOE 2 GR GLOSSY BLACK	2GRUPPI/2GROUPS
6G	10017334	PANNELLO POSTERIORE ZOE 2 GR ROSSO	REAR PANEL ZOE 2 GR RED	2GRUPPI/2GROUPS
6H	10017336A	PANNELLO POSTERIORE ZOE 2 GR VIOLA	REAR PANEL ZOE 2 GR VIOLET	2GRUPPI/2GROUPS
6I	10017338	PANNELLO POSTERIORE ZOE 2 GR NERO OPACO	REAR PANEL ZOE 2 GR MATT BLACK	2GRUPPI/2GROUPS
6L	10017342	PANNELLO POSTERIORE ZOE 2 GR GIALLO*	REAR PANEL ZOE 2 GR YELLOW	2GRUPPI/2GROUPS
6M	10017346	PANNELLO POSTERIORE ZOE 2 GR ARANCIONE	REAR PANEL ZOE 2 GR ORANGE	2GRUPPI/2GROUPS
6N	10017532	PANNELLO POSTERIORE ZOE 3 GR NERO LUCIDO	REAR PANEL ZOE 3 GR GLOSSY BLACK	3GRUPPI/3GROUPS
6O	10017534	PANNELLO POSTERIORE ZOE 3 GR ROSSO	REAR PANEL ZOE 3 GR RED	3GRUPPI/3GROUPS
6P	10017536A	PANNELLO POSTERIORE ZOE 3 GR VIOLA	REAR PANEL ZOE 3 GR VIOLET	3GRUPPI/3GROUPS
6Q	10017538	PANNELLO POSTERIORE ZOE 3 GR NERO OPACO	REAR PANEL ZOE 3 GR MATT BLACK	3GRUPPI/3GROUPS
6R	10017542	PANNELLO POSTERIORE ZOE 3 GR GIALLO*	REAR PANEL ZOE 3 GR YELLOW*	3GRUPPI/3GROUPS
6S	10017546	PANNELLO POSTERIORE ZOE 3 GR ARANCIONE	REAR PANEL ZOE 3 GR ORANGE	3GRUPPI/3GROUPS
7	10809011	DADO FLANGIATO 4 MA	FLANGED NUT 4 MA	
8	10405540	PRESSORE A SFERA E MOLLA	BALL SPRING PLUNGER	

*Disponibilità limitata. Colore non più in produzione/ Limited availability . Color out of production.



TAVOLA
DRAWING

PANNELLI / PANELS

1

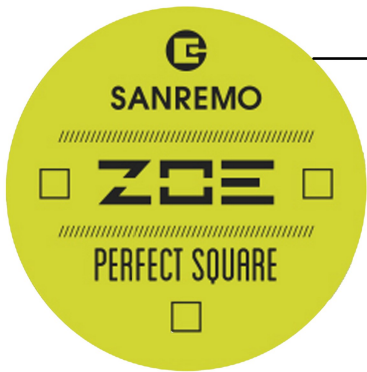
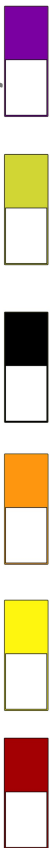

RIF. POS	CODICE CODE	DESCRIZIONE	DESCRIPTION	NOTE NOTES
9	10017864A	STAFFA SUPPORTO CENTRALINA TVC	ELECTRICAL BOX CLAMP TVC	TVC
10A	10017672	PANNELLO DX ZOE 1GR NERO LUCIDO	RIGHT PANEL ZOE 1GR GLOSSY BLACK	1GRUPPO/1GROUP
10B	10017674	PANNELLO DX ZOE 1GR ROSSO	RIGHT PANEL ZOE 1GR RED	1GRUPPO/1GROUP
10C	10017676A	PANNELLO DX ZOE 1GR VIOLA	RIGHT PANEL ZOE 1GR VIOLET	1GRUPPO/1GROUP
10D	10017678	PANNELLO DX ZOE 1GR NERO OPACO	RIGHT PANEL ZOE 1GR MATT BLACK	1GRUPPO/1GROUP
10E	10017682	PANNELLO DX ZOE 1GR GIALLO*	RIGHT PANEL ZOE 1GR YELLOW*	1GRUPPO/1GROUP
10F	10017372	PANNELLO DX ZOE 2-3 GR NERO LUCIDO	RIGHT PANEL ZOE 2-3 GR GLOSSY BLACK	2-3 GRUPPI/2-3 GROUPS
10G	10017374	PANNELLO DX ZOE 2-3 GR ROSSO	RIGHT PANEL ZOE 2-3 GR RED	2-3 GRUPPI/2-3 GROUPS
10H	10017376A	PANNELLO DX ZOE 2-3 GR VIOLA	RIGHT PANEL ZOE 2-3 GR VIOLET	2-3 GRUPPI/2-3 GROUPS
10I	10017378	PANNELLO DX ZOE 2-3 GR NERO OPACO	RIGHT PANEL ZOE 2-3 GR MATT BLACK	2-3 GRUPPI/2-3 GROUPS
10L	10017382	PANNELLO DX ZOE 2-3 GR GIALLO*	RIGHT PANEL ZOE 2-3 GR YELLOW*	2-3 GRUPPI/2-3 GROUPS
10M	10017386	PANNELLO DX ZOE 2-3 GR ARANCIONE	RIGHT PANEL ZOE 2-3 GR ORANGE	2-3 GRUPPI/2-3 GROUPS
11	10805027A	VITE TBL M4X10 A2	TBL SCREW M4X10 A2	
12	10352065	PIEDINO D.50X55	FOOT D.50X55	
13A	10017602C	TELAIO ZOE 1GR NERO OPACO	FRAME ZOE 1GR MATT BLACK	1GRUPPO/1GROUP
13B	10017604C	TELAIO ZOE 1GR BIANCO	FRAME ZOE 1GR WHITE	1GRUPPO/1GROUP
13C	10017302E	TELAIO ZOE 2 GR NERO OPACO	FRAME ZOE 2 GR MATT BLACK	2GRUPPI/2GROUPS
13D	10017304E	TELAIO ZOE 2 GR BIANCO	FRAME ZOE 2 GR WHITE	2GRUPPI/2GROUPS
13E	10017502E	TELAIO ZOE 3GR NERO OPACO	FRAME ZOE 3GR MATT BLACK	3GRUPPI/3GROUPS
13F	10017504E	TELAIO ZOE 3GR BIANCO	FRAME ZOE 3GR WHITE	3GRUPPI/3GROUPS
14A	10112268C	PULSANTIERA ZOE SED 6 TASTI	BUTTON ZOE SED 6 KEYS	SED
14B	10112274A	PULSANTIERA ZOE SAP 2 TASTI	BUTTON ZOE SAP 2 KEYS	SAP
15A	10017412A	SUPPORTO PULSANTIERA ZOE SED NERO OPACO	BUTTON SUPPORT ZOE SED MATT BLACK	SED
15B	10017414A	SUPPORTO PULSANTIERA ZOE SED BIANCO	BUTTON SUPPORT ZOE SED WHITE	SED
15C	10017432A	SUPPORTO PULSANTIERA ZOE SAP NERO OPACO	BUTTON SUPPORT ZOE SAP MATT BLACK	SAP
15D	10017434A	SUPPORTO PULSANTIERA ZOE SAP BIANCO	BUTTON SUPPORT ZOE SAP WHITE	SAP
16A	10017712C	FRONTALE INFERIORE ZOE 1GR NERO OPACO	LOWER FRONT ZOE 1GR MATT BLACK	1GRUPPO/1GROUP
16B	10017714C	FRONTALE INFERIORE ZOE 1GR BIANCO	LOWER FRONT ZOE 1GR WHITE	1GRUPPO/1GROUP
16C	10017472D	FRONTALE INFERIORE ZOE 2GR NERO OPACO	LOWER FRONT ZOE 2 GR MATT BLACK	2GRUPPI/2GROUPS

*Disponibilità limitata. Colore non più in produzione/ Limited availability . Color out of production.



TAVOLA
DRAWING

PANNELLI / PANELS

1

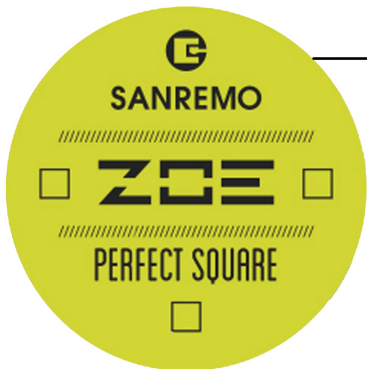
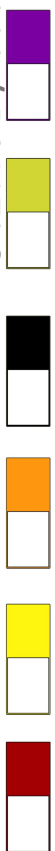

RIF. POS	CODICE CODE	DESCRIZIONE	DESCRIPTION	NOTE NOTES
16D	10017474D	FRONTALE INFERIORE ZOE 2GR BIANCO	LOWER FRONT ZOE 2 GR WHITE	2GRUPPI/2GROUPS
16E	10017572C	FRONTALE INFERIORE ZOE 3GR NERO OPACO	LOWER FRONT ZOE 3 GR MATT BLACK	3GRUPPI/3GROUPS
16F	10017574C	FRONTALE INFERIORE ZOE 3GR BIANCO	LOWER FRONT ZOE 3 GR WHITE	3GRUPPI/3GROUPS
17A	10017482	PIASTRA TAMPONAMENTO FRONTALE INFERIORE NERO OPACO	REAR PLATE LOWER FRONT MATT BLACK	
17B	10017484	PIASTRA TAMPONAMENTO FRONTALE INFERIORE BIANCO	REAR PLATE LOWER FRONT WHITE	
18	10955056A	ETICHETTA "SANREMO"	LABEL "SANREMO"	
19	10017492	PIASTRA ANTISTRISCIAMENTO	SCRATCH PLATE	
20A	10017622	PIATTO DI SCARICO ZOE 1GR	DRAIN DISH ZOE 1GR	1GRUPPO/1GROUP
20B	10017322	PIATTO DI SCARICO ZOE 2GR	DRAIN DISH ZOE 2GR	2GRUPPI/2GROUPS
20C	10017522	PIATTO DI SCARICO ZOE 3GR	DRAIN DISH ZOE 3GR	3GRUPPI/3GROUPS
21A	10017628A	GRIGLIA DI SCARICO ZOE 1GR	DRAIN GRID ZOE 1GR	1GRUPPO/1GROUP
21B	10026520	GRIGLIA DI SCARICO ZOE 2GR	DRAIN GRID ZOE 2GR	2GRUPPI/2GROUPS
21C	10017528A	GRIGLIA DI SCARICO ZOE 3GR	DRAIN GRID ZOE 3GR	3GRUPPI/3GROUPS
22	10803344	VITE TSP M4X10 A2	TSP SCREW M4X10 A2	
23A	10017620	PROTEZIONE FRONTALE ZOE 1 GR	FRONT PANEL ZOE 1GR	1GRUPPO/1GROUP
23B	10017320A	PROTEZIONE FRONTALE ZOE 2 GR	FRONT PANEL ZOE 2GR	2GRUPPI/2GROUPS
23C	10017520	PROTEZIONE FRONTALE ZOE 3 GR	FRONT PANEL ZOE 3GR	3GRUPPI/3GROUPS
24A	10017652	PROTEZIONE GRUPPI ZOE 1 GR NERO LUCIDO	PROTECTION PANEL GROUP ZOE 1GR GLOSSY BLACK	1GRUPPO/1GROUP
24B	10017658	PROTEZIONE GRUPPI ZOE 1 GR NERO OPACO	PROTECTION PANEL GROUP ZOE 1GR MATT BLACK	1GRUPPO/1GROUP
24C	10017654	PROTEZIONE GRUPPI ZOE 1 GR ROSSO	PROTECTION PANEL GROUP ZOE 1GR RED	1GRUPPO/1GROUP
24D	10017656A	PROTEZIONE GRUPPI ZOE 1 GR VIOLA	PROTECTION PANEL GROUP ZOE 1GR VIOLET	1GRUPPO/1GROUP
24E	10017662	PROTEZIONE GRUPPI ZOE 1 GR GIALLO*	PROTECTION PANEL GROUP ZOE 1GR YELLOW*	1GRUPPO/1GROUP
24F	10017352	PROTEZIONE GRUPPI ZOE 2GR NERO LUCIDO	PROTECTION PANEL GROUP ZOE 2GR GLOSSY BLACK	2GRUPPI/2GROUPS
24G	10017354	PROTEZIONE GRUPPI ZOE 2GR ROSSO	PROTECTION PANEL GROUP ZOE 2GR RED	2GRUPPI/2GROUPS
24H	10017356A	PROTEZIONE GRUPPI ZOE 2GR VIOLA	PROTECTION PANEL GROUP ZOE 2GR VIOLET	2GRUPPI/2GROUPS
24I	10017358	PROTEZIONE GRUPPI ZOE 2GR NERO OPACO	PROTECTION PANEL GROUP ZOE 2GR MATT BLACK	2GRUPPI/2GROUPS
24L	10017362	PROTEZIONE GRUPPI ZOE 2GR GIALLO*	PROTECTION PANEL GROUP ZOE 2GR YELLOW*	2GRUPPI/2GROUPS
24M	10017366	PROTEZIONE GRUPPI ZOE 2GR ARANCIONE	PROTECTION PANEL GROUP ZOE 2GR ORANGE	2GRUPPI/2GROUPS
24N	10017566	PROTEZIONE GRUPPI ZOE 3GR ARANCIONE	PROTECTION PANEL GROUP ZOE 3GR ORANGE	3GRUPPI/3GROUPS
24O	10017552	PROTEZIONE GRUPPI ZOE 3GR NERO LUCIDO	PROTECTION PANEL GROUP ZOE 3GR GLOSSY BLACK	3GRUPPI/3GROUPS
24P	10017554	PROTEZIONE GRUPPI ZOE 3GR ROSSO	PROTECTION PANEL GROUP ZOE 3GR RED	3GRUPPI/3GROUPS

*Disponibilità limitata. Colore non più in produzione/ Limited availability . Color out of production.



TAVOLA
DRAWING

PANNELLI / PANELS

1

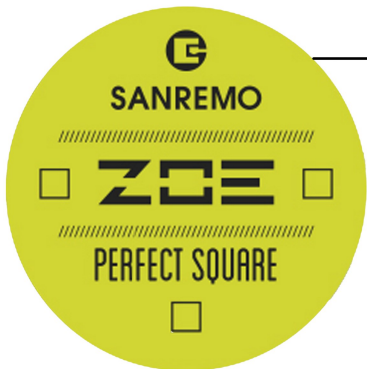

RIF. POS	CODICE CODE	DESCRIZIONE	DESCRIPTION	NOTE NOTES
24Q	10017556A	PROTEZIONE GRUPPI ZOE 3GR VIOLA	PROTECTION PANEL GROUP ZOE 3GR VIOLET	3GRUPPI/3GROUPS
24R	10017558	PROTEZIONE GRUPPI ZOE 3GR NERO OPACO	PROTECTION PANEL GROUP ZOE 3GR MATT BLACK	3GRUPPI/3GROUPS
24S	10017562	PROTEZIONE GRUPPI ZOE 3GR GIALLO*	PROTECTION PANEL GROUP ZOE 3GR YELLOW*	3GRUPPI/3GROUPS
25A	10017692	PANNELLO SX ZOE 1GR NERO LUCIDO	LEFT PANEL ZOE 1GR GLOSSY BLACK	1GRUPPO/1GROUP
25B	10017694	PANNELLO SX ZOE 1GR ROSSO	LEFT PANEL ZOE 1GR RED	1GRUPPO/1GROUP
25C	10017696A	PANNELLO SX ZOE 1GR VIOLA	LEFT PANEL ZOE 1GR VIOLET	1GRUPPO/1GROUP
25D	10017698	PANNELLO SX ZOE 1GR NERO OPACO	LEFT PANEL ZOE 1GR MATT BLACK	1GRUPPO/1GROUP
25E	10017702	PANNELLO SX ZOE 1GR GIALLO*	RIGHT PANEL ZOE 1GR YELLOW*	1GRUPPO/1GROUP
25F	10017392	PANNELLO SX ZOE 2-3 GR NERO LUCIDO	RIGHT PANEL ZOE 2-3 GR GLOSSY BLACK	2-3 GRUPPI/2-3 GROUPS
25G	10017394	PANNELLO SX ZOE 2-3 GR ROSSO	RIGHT PANEL ZOE 2-3 GR RED	2-3 GRUPPI/2-3 GROUPS
25H	10017396A	PANNELLO SX ZOE 2-3 GR VIOLA	RIGHT PANEL ZOE 2-3 GR VIOLET	2-3 GRUPPI/2-3 GROUPS
25I	10017398	PANNELLO SX ZOE 2-3 GR NERO OPACO	RIGHT PANEL ZOE 2-3 GR MATT BLACK	2-3 GRUPPI/2-3 GROUPS
25L	10017402	PANNELLO SX ZOE 2-3 GR GIALLO*	RIGHT PANEL ZOE 2-3 GR YELLOW*	2-3 GRUPPI/2-3 GROUPS
25M	10017406	PANNELLO SX ZOE 2-3 GR ARANCIO	RIGHT PANEL ZOE 2-3 GR ORANGE	2-3 GRUPPI/2-3 GROUPS
26	10092162B	TAPPO MANOPOLA VAPORE	STEAM KNOB CAP	
27	10402040	RONDELLA RUBINETTO	WASHER TAP	
28	10806372	COPPIGLIA RUBINETTO	COTTER TAP	
29	10092164A	MANOPOLA VAPORE	STEAM KNOB	
30	10809012	DADO FLANGIATO 6MA	FLANGED NUT 6MA	
31	10955025A	ETICHETTA SIMBOLO TERRA	GRAUNDED LABEL SYMBOL	
32	10105030	PASSACAVO	CABLE PASS	
33	10105024	VITE TC PASSACAVO	CABLEPASS SCREW	
34	10105022	PRESSACAVO	CABLE PRESS	
35A	10019242	PANNELLO SX ZOE 2-3 GR NERO LUCIDO ANTITRACIMAZIONE	RIGHT PANEL ZOE 2-3 GR GLOSSY BLACK ANTI-SPILL OVER	2-3 GRUPPI/2-3 GROUPS ANTITRACIMAZIONE/ANTI-SPILL OVER
35B	10019244	PANNELLO SX ZOE 2-3 GR ROSSO ANTITRACIMAZIONE	RIGHT PANEL ZOE 2-3 GR RED ANTI-SPILL OVER	2-3 GRUPPI/2-3 GROUPS ANTITRACIMAZIONE/ANTI-SPILL OVER
35C	10019246	PANNELLO SX ZOE 2-3 GR VIOLA ANTITRACIMAZIONE	RIGHT PANEL ZOE 2-3 GR VIOLET ANTI-SPILL OVER	2-3 GRUPPI/2-3 GROUPS ANTITRACIMAZIONE/ANTI-SPILL OVER

*Disponibilità limitata. Colore non più in produzione/ Limited availability . Color out of production.



TAVOLA
DRAWING



RIF. POS	CODICE CODE	DESCRIZIONE	DESCRIPTION	NOTE NOTES
35D	10019248	PANNELLO SX ZOE 2-3 GR NERO OPACO ANTITRACIMAZIONE	RIGHT PANEL ZOE 2-3 GR MATT BLACK ANTI-SPILL OVER	2-3 GRUPPI/2-3 GROUPS ANTITRACIMAZIONE/ANTI-SPILL OVER
35E	10019250	PANNELLO SX ZOE 2-3 GR GIALLO *ANTITRACIMAZIONE	RIGHT PANEL ZOE 2-3 GR YELLOW* ANTI-SPILL OVER	2-3 GRUPPI/2-3 GROUPS ANTITRACIMAZIONE/ANTI-SPILL OVER
35F	10018002	PANNELLO SX ZOE 1GR NERO LUCIDO ANTITRACIMAZIONE	LEFT PANEL ZOE 1GR GLOSSY BLACK ANTI-SPILL OVER	1GRUPPO/1GROUP ANTITRACIMAZIONE/ANTI-SPILL OVER
35G	10018004	PANNELLO SX ZOE 1GR ROSSO ANTITRACIMAZIONE	LEFT PANEL ZOE 1GR RED ANTI-SPILL OVER	1GRUPPO/1GROUP ANTITRACIMAZIONE/ANTI-SPILL OVER
35H	10018006	PANNELLO SX ZOE 1GR VIOLA ANTITRACIMAZIONE	LEFT PANEL ZOE 1GR VIOLET ANTI-SPILL OVER	1GRUPPO/1GROUP ANTITRACIMAZIONE/ANTI-SPILL OVER
35I	10018008	PANNELLO SX ZOE 1GR NERO OPACO ANTITRACIMAZIONE	LEFT PANEL ZOE 1GR MATT BLACK ANTI-SPILL OVER	1GRUPPO/1GROUP ANTITRACIMAZIONE/ANTI-SPILL OVER
36A	10019170	PROTEZIONE FRONTALE ZOE 1 GR ANTITRACIMAZIONE	FRONT PANEL ZOE 1GR ANTI-SPILL OVER	1GRUPPO/1GROUP ANTITRACIMAZIONE/ANTI-SPILL OVER
36B	10019150	PROTEZIONE FRONTALE ZOE 2 GR ANTITRACIMAZIONE	FRONT PANEL ZOE 2GR ANTI-SPILL OVER	2GRUPPI/2GROUPS ANTITRACIMAZIONE/ANTI-SPILL OVER
36C	10019160	PROTEZIONE FRONTALE ZOE 3 GR ANTITRACIMAZIONE	FRONT PANEL ZOE 3GR ANTI-SPILL OVER	3GRUPPI/3GROUPS ANTITRACIMAZIONE/ANTI-SPILL OVER
37A	10017974	PIASTRA TAMPONAMENTO TELAIO ZOE 1 GR ANTITRACIMAZIONE	REAR PLATE FRAME ZOE 1GR ANTI-SPILL OVER	1GRUPPO/1GROUP ANTITRACIMAZIONE/ANTI-SPILL OVER
37B	10019140A	PIASTRA TAMPONAMENTO TELAIO ZOE 2 GR ANTITRACIMAZIONE	REAR PLATE FRAME ZOE 2GR ANTI-SPILL OVER	2GRUPPI/2GROUPS ANTITRACIMAZIONE/ANTI-SPILL OVER
37C	10019030B	PIASTRA TAMPONAMENTO TELAIO ZOE 3 GR ANTITRACIMAZIONE	REAR PLATE FRAME ZOE 3GR ANTI-SPILL OVER	3GRUPPI/3GROUPS ANTITRACIMAZIONE/ANTI-SPILL OVER
38A	10017972	PIATTO DI SCARICO ZOE 1GR ANTITRACIMAZIONE	DRAIN DISH 1GR ANTI-SPILL OVER	1GRUPPO/1GROUP ANTITRACIMAZIONE/ANTI-SPILL OVER
38B	10019136	PIATTO DI SCARICO ZOE 2GR ANTITRACIMAZIONE	DRAIN DISH 2GR ANTI-SPILL OVER	2GRUPPI/2GROUPS ANTITRACIMAZIONE/ANTI-SPILL OVER
38C	10019026	PIATTO DI SCARICO ZOE 3GR ANTITRACIMAZIONE	DRAIN DISH 3GR ANTI-SPILL OVER	3GRUPPI/3GROUPS ANTITRACIMAZIONE/ANTI-SPILL OVER
39A	10019262	PANNELLO DX ZOE 2-3 GR NERO LUCIDO ANTITRACIMAZIONE	RIGHT PANEL ZOE 2-3 GR GLOSSY BLACK ANTI-SPILL OVER	2-3 GRUPPI/2-3 GROUPS ANTITRACIMAZIONE/ANTI-SPILL OVER

*Disponibilità limitata. Colore non più in produzione/ Limited availability . Color out of production.

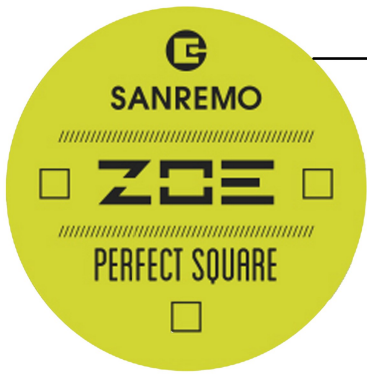
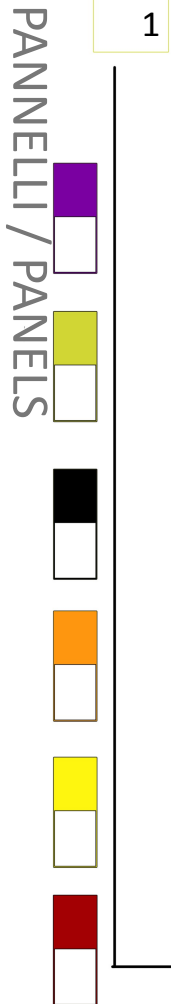

TAVOLA
DRAWING

PANNELLI / PANELS

1

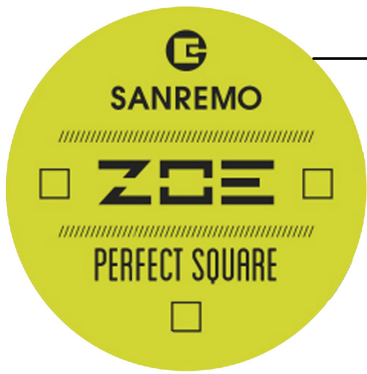
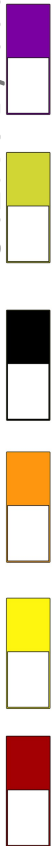

RIF. POS	CODICE CODE	DESCRIZIONE	DESCRIPTION	NOTE NOTES
39B	10019264	PANNELLO DX ZOE 2-3 GR ROSSO ANTITRACIMAZIONE	RIGHT PANEL ZOE 2-3 GR RED ANTI-SPILL OVER	2-3 GRUPPI/2-3 GROUPS ANTITRACIMAZIONE/ANTI-SPILL OVER
39C	10019266	PANNELLO DX ZOE 2-3 GR VIOLA ANTITRACIMAZIONE	RIGHT PANEL ZOE 2-3 GR VIOLET ANTI-SPILL OVER	2-3 GRUPPI/2-3 GROUPS ANTITRACIMAZIONE/ANTI-SPILL OVER
39D	10019268	PANNELLO DX ZOE 2-3 GR NERO OPACO ANTITRACIMAZIONE	RIGHT PANEL ZOE 2-3 GR MATT BLACK ANTI-SPILL OVER	2-3 GRUPPI/2-3 GROUPS ANTITRACIMAZIONE/ANTI-SPILL OVER
39E	10019270	PANNELLO DX ZOE 2-3 GR GIALLO * ANTITRACIMAZIONE	RIGHT PANEL ZOE 2-3 GR YELLOW * ANTI-SPILL OVER	2-3 GRUPPI/2-3 GROUPS ANTITRACIMAZIONE/ANTI-SPILL OVER
39F	10017982A	PANNELLO DX ZOE 1GR NERO LUCIDO ANTITRACIMAZIONE	RIGHT PANEL ZOE 1GR GLOSSY BLACK ANTI-SPILL OVER	1GRUPPO/1GROUP ANTITRACIMAZIONE/ANTI-SPILL OVER
39G	10017984	PANNELLO DX ZOE 1GR ROSSO ANTITRACIMAZIONE	RIGHT PANEL ZOE 1GR RED ANTI-SPILL OVER	1GRUPPO/1GROUP ANTITRACIMAZIONE/ANTI-SPILL OVER
39H	10017986	PANNELLO DX ZOE 1GR VIOLA ANTITRACIMAZIONE	RIGHT PANEL ZOE 1GR VIOLET ANTI-SPILL OVER	1GRUPPO/1GROUP ANTITRACIMAZIONE/ANTI-SPILL OVER
39I	10017988	PANNELLO DX ZOE 1GR NERO OPACO ANTITRACIMAZIONE	RIGHT PANEL ZOE 1GR MATT BLACK ANTI-SPILL OVER	1GRUPPO/1GROUP ANTITRACIMAZIONE/ANTI-SPILL OVER
40	10805126	VITE TC+ M3X6	SCREW TC+ M3X6	
41	10805562	RONDELLA D4x16x1.5	WASHER D4X16X1,5	
42	10803536	RONDELLA DENTATA D6,2	TOOTHED WASHER D 6,2	
43	10017870A	STAFFA SUPPORTO CENTRALINA ZOE TVC	ELECTRICAL BOX CLAMP ZOE TVC	TVC

*Disponibilità limitata. Colore non più in produzione/ Limited availability . Color out of production.

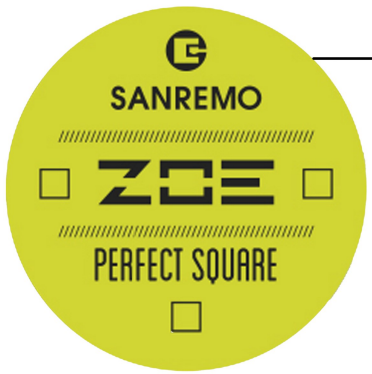

LANCIA VAPORE — LANCIA AUTO STEAMER / STEAM PIPE — AUTO STEAMER

TAVOLA
DRAWING

2

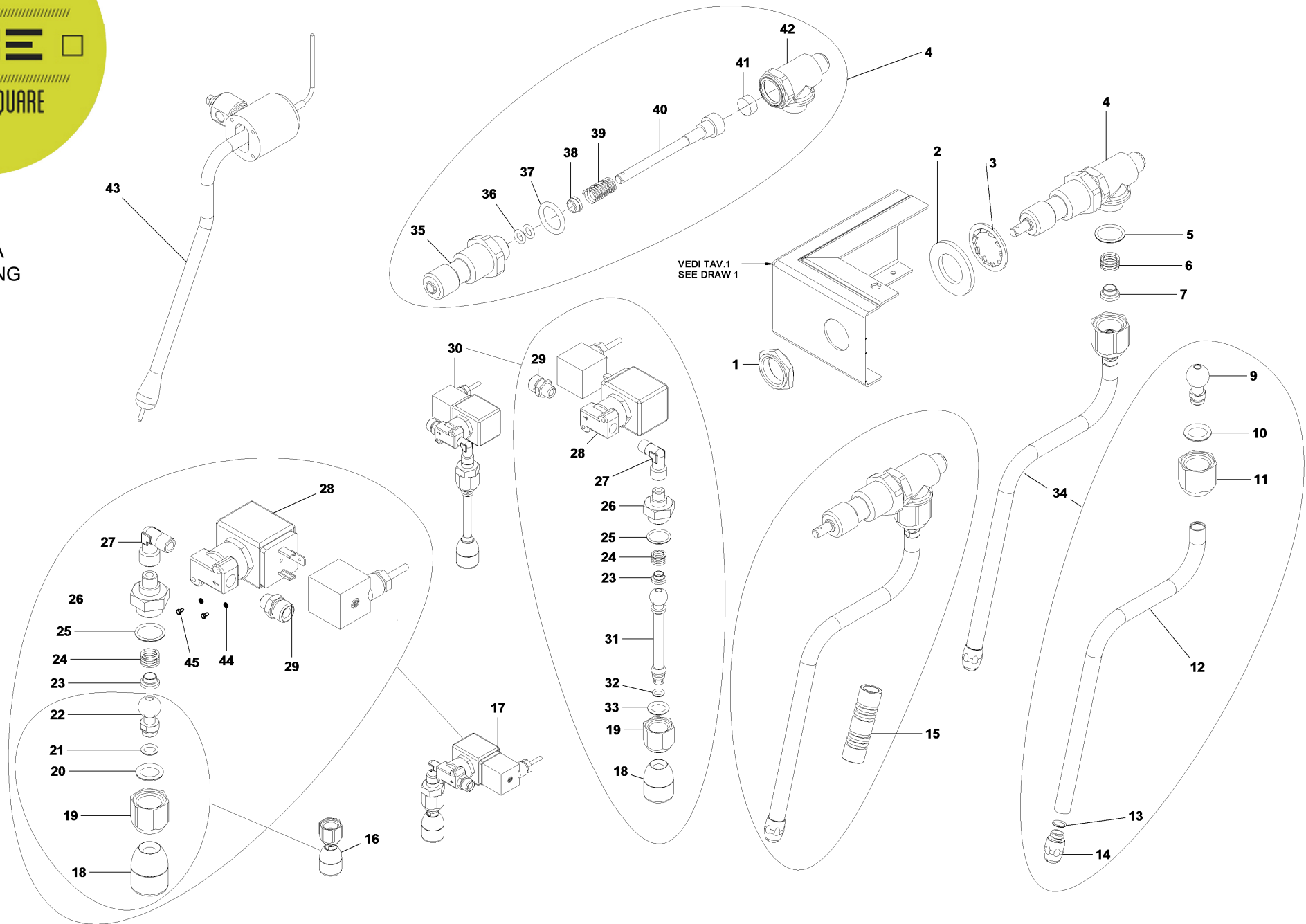

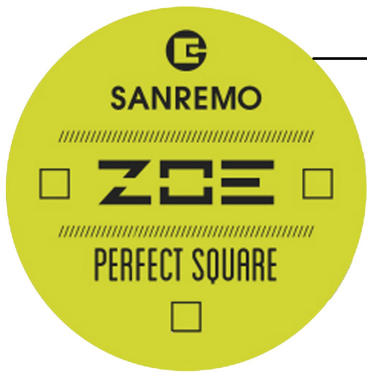

LANCIA VAPORE — LANCIA AUTO STEAMER / STEAM PIPE — AUTO STEAMER

TAVOLA
DRAWING

2

RIF. POS	CODICE CODE	DESCRIZIONE	DESCRIPTION	NOTE NOTES
1	10402028	MEZZO DADO 1/2"	HALF NUT 1/2"	
2	10803547	RONDELLA D20	WASHER D20	
3	10806312	RONDELLA D21 DENTATA	TOOTHED WASHER D21	
4	10402120C	CORPO RUBINETTO COMPLETO	FULL TAP BODY	
5	10402056A	OR 2062 VITON	OR 2062 VITON	
6	10402043	MOLLA SNODO RUBINETTO	TAP JOINT SPRING	
7	10402054A	SCODELLINO SNODO RUBINETTO	TAP JOINT ADJUSTER	
9	10402288	SNODO A SFERA INOX	INOX JOINT BALL	
10	10402082	OR SNODO LANCIA	PIPE JOINT OR	
11	14402282	DADO LANCIA VAPORE	STEAM PIPE NUT	
12	10402274	TUBO LANCIA VAPORE	STEAM PIPE TUBE	
13	10402081	OR TUBO LANCIA 188 EPDM	PIPE TUBE OR 188 EPDM	
14A	10402276	GETTO LANCIA VAPORE 2 FORI	STEAM PIPE JET 2 HOLES	
14B	10402279	GETTO LANCIA VAPORE 4 FORI	STEAM PIPE JET 4 HOLES	
15	10753052	GOMMINO ANTISCIVOLO TUBO VAPORE	STEAMER PIPE NO SLIP RUBBER	
16	14402143A	DOCCIA CORTA ACQUA COMPLETA	COMPLETA WATER SHORT SHOWER	
17	10401982	RUBINETTO ACQUA COMPLETO ZOE 2 GR 230V	COMPLETE WATER TAP ZOE 2GR 230V	2 GRUPPI/ 2 GROUPS
18	14402140	DOCCIA CORTA ACQUA	SHORT WATER SHOWER	
19	14402052A	DADO SNODO RUBINETTO ACQUA	WHATER BALL TAP NUT	
20	10402082	OR SNODO LANCIA D10	JOINT PIPE OR D10	
21	10505018	OR DOCCIA ACQUA D 7.2X 1.9	WATER SHOWER OR D 7.2 X 1.9	
22	10402266	SNODO A SFERA INOX RUBINETTO ACQUA	TAP WHATER INOX JOINT BALL	
23	10402054A	SCODELLINO SNODO RUBINETTO	TAP JOINT ADJUSTER	
24	10402043	MOLLA SNODO RUBINETTO	TAP JOINT SPRING	
25	10402056A	OR D 15,6 X 1,78	OR D 15,6 X 1,78	
26	14859028B	RIDUZIONE 1/8" M 3/8" M	REDUCTION 1/8" M 3/8" M	
27	10857210A	RACCORDO 1/8-1/8" FM	QUICK 1/8-1/8" FM	
28	10303108	ELETTRIVALVOLA 2 VIE 1/8" 230V	2 WAYS 1/8" 230V SOLENOID	
29	10857050B	RACCORDO DRITTO 8-1/8" M	QUICK 8- 1/8" M	
30	10401979	RUBINETTO ACQUA COMPLETO ZOE 1 GR 230V	COMPLETE WATHER TAP ZOE 1GR 230V	1 GRUPPO / 1 GROUP
31	10022140A	TUBETTO RUBINETTO ACQUA	WATHER TAP TUBE	
32	10502041A	OR 2025 D6,07X1,78	OR 2025 D6,07X1,78	1 GRUPPO / 1 GROUP

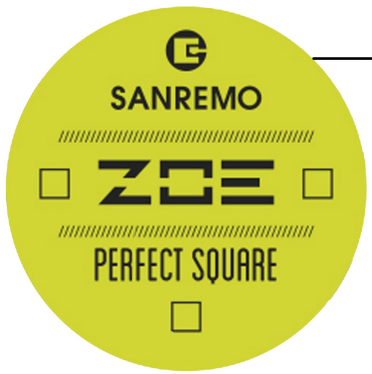

CALDAIA / BOILER

TAVOLA
 DRAWING

3

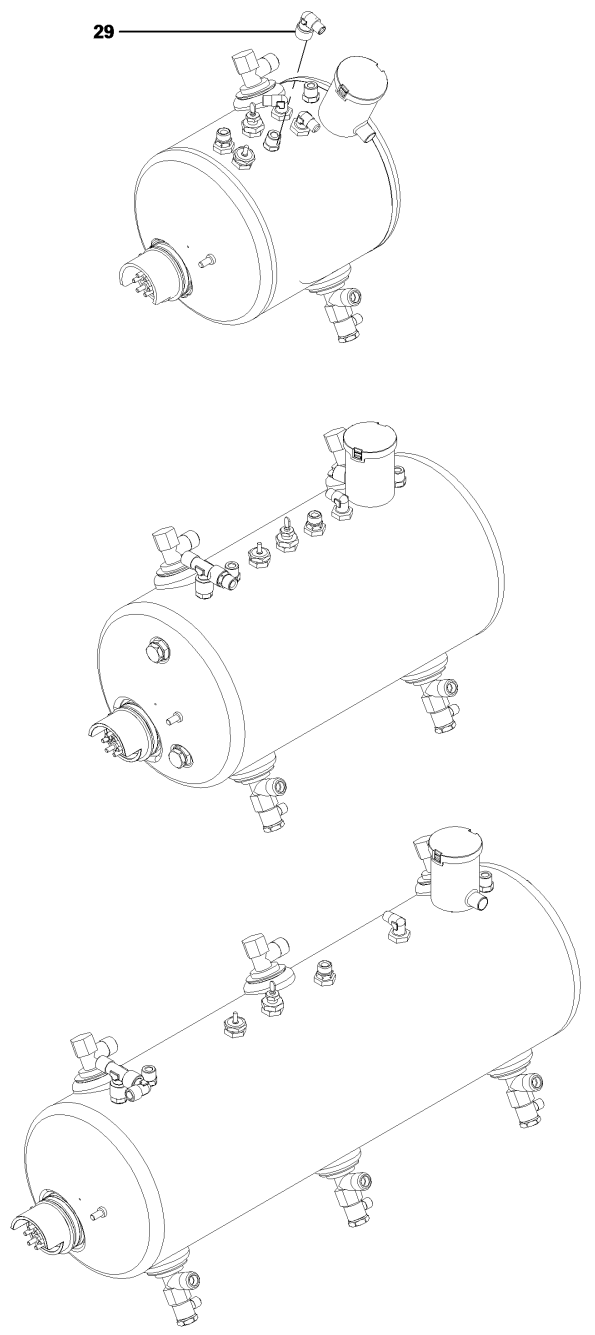
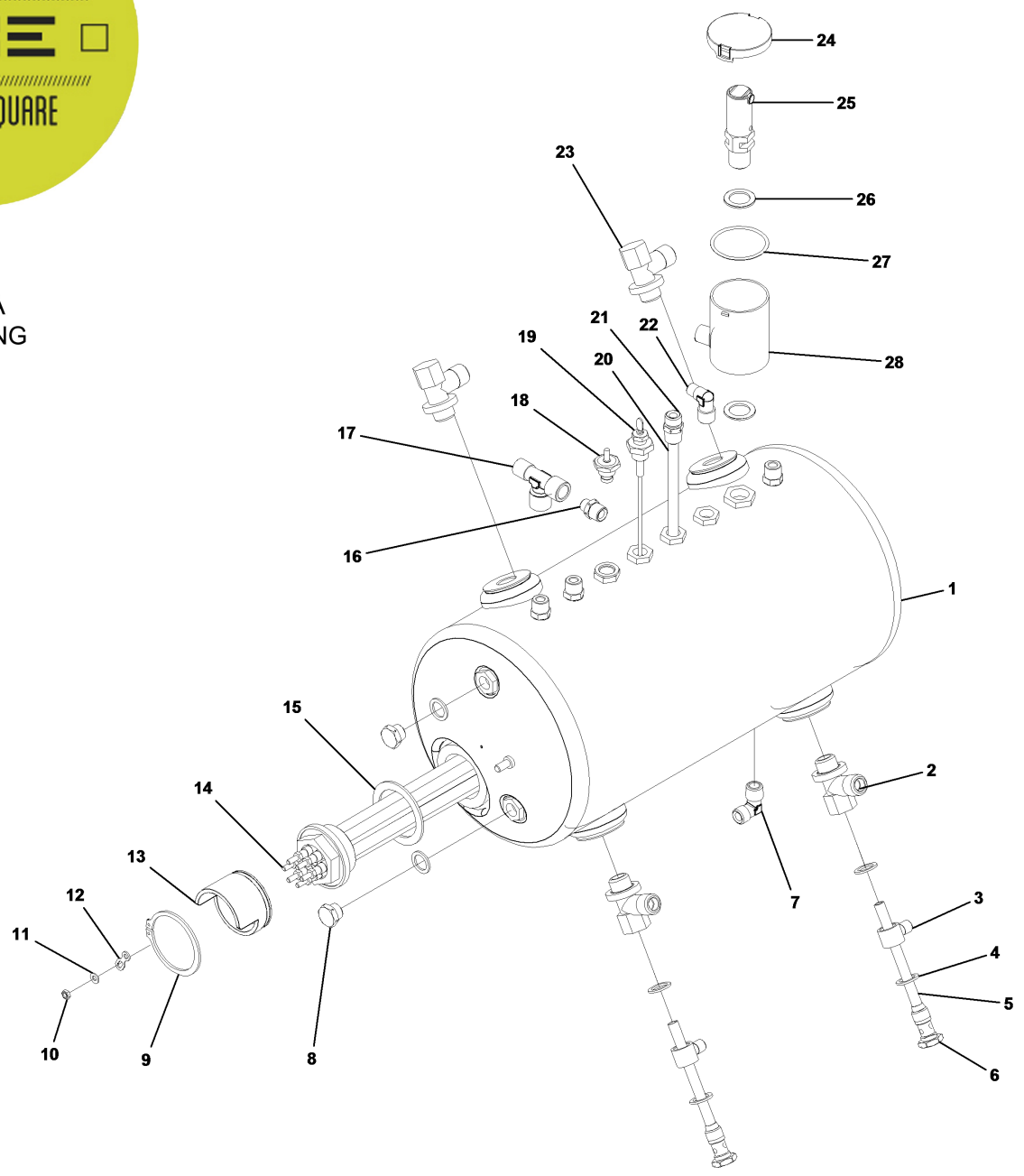
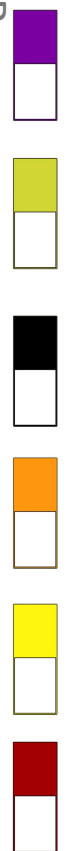

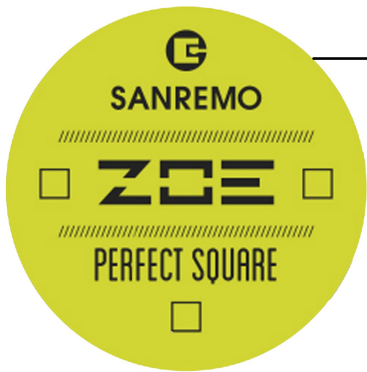

CALDAIA / BOILER

TAVOLA
DRAWING

3

RIF. POS	CODICE CODE	DESCRIZIONE	DESCRIPTION	NOTE NOTES
1A	10002635C	CALDAIA 1GR D180	BOILER 1GR D180	1 GRUPPO/1 GROUP
1B	10002670A	CALDAIA 2GR D190	BOILER 2GR D190	2 GRUPPI/ 2 GROUPS
1C	10002637B	CALDAIA 3GR D180	BOILER 3GR D180	3 GRUPPI/ 3 GROUPS
2	10853258	RACCORDO SCAMBIATORE INFERIORE 1/4X3/8X3/8	EXCHANGERS LOWER JOINT 1/4X3/8X3/8	
3	10857240A	RACCORDO GIREVOLE 6-1/4"	REVOLVING JOINT 6-1/4"	
4	10852180	RONDELLA RAME 1/4"	COPPER WASHER 1/4"	
5	10042040B	INIETTORE TEFLON CON RACCORDO	TEFLON INJECTOR WHIT JOINT	
7	10857060A	RACCORDO 8-1/4" GOMITO	ELBOW JOINT 8-1/4"	
8	10857540B	RACCORDO 1/4" M TAPPO	JOINT1/4" M TOP	
9	10806286	ANELLO SEEGER A52X2	CIRCLIP A52X2	
10A	10806050	DADO M4 PER RESISTENZA	ELECTRIC RESISTANCE NUT M4	
10B	10806052	DADO 1/8" PER RESISTENZA HELKRA	HELKRA ELECTRIC RESISTANCE NUT 1/8"	
11A	10809024	RONDELLA D4	WASHER D4	
11B	10803533	RONDELLA PER RESISTENZA HELKRA	HELKRA ELECTRIC RESISTANCE WASHER	
12A	10106060	PONTE COLLEGAMENTO RESISTENZA	ELECTRIC RESISTANCE CONNECTION BRIDGE	
12B	10106070	PONTE COLLEGAMENTO RESISTENZA HELKRA	HELKRA ELECTRIC RESISTANCE CONNECTION BRIDGE	
13	10455100B	PROTEZIONE COLLEGAMENTI ELETTRICI RESISTENZA	ELECTRIC CONNECTION RESISTANCE PROTECTION	
14A	10455051A	RESISTENZA 1950W 120V 1 GR	ELECTRIC RESISTANCE 1950W 120V 1GR	1 GRUPPO/1 GROUP
14B	10455031A	RESISTENZA 1950W 220V 1 GR	ELECTRIC RESISTANCE 1950W 220V 1GR	2 GRUPPO/1 GROUP
14C	10455152	RESISTENZA 2400W 230V 1 GR	ELECTRIC RESISTANCE 2400W 230V 1GR	1 GRUPPO/1 GROUP
14D	10455032A	RESISTENZA 2700W 220V 2 GR	ELECTRIC RESISTANCE 2700W 220V 2GR	2 GRUPPI/ 2 GROUPS
14E	10455053A	RESISTENZA 2700W 120V 2 GR	ELECTRIC RESISTANCE 2700W 120V 2GR	2 GRUPPI/ 2 GROUPS
14F	10455162	RESISTENZA 4500W 230V 2 GR	ELECTRIC RESISTANCE 4500W 230V 2GR	2GRUPPI/ 2 GROUPS
14G	10455070	RESISTENZA 5100W 220V 3 GR	ELECTRIC RESISTANCE 5100W 220V 3GR	3GRUPPI/ 3 GROUPS
15	10502020	RONDELLA PTFE PER RESISTENZA	PTFE WASHER RESISTANCE	
16	10857052	RACCORDO 1/4" - 1/8" CONICI DRITTO M	JOINT 1/4" - 1/8" CONICAL STRAIGHT	
17	10857821	RACCORDO T 1/4" M/F/F	JOINT T 1/4" M/F/F	
18	10652040A	VALVOLA SFIATO CALDAIA	BOILER RELIEF VALVE	
19A	10112042	SONDA DI LIVELLO 140 mm	LEVEL CHECK ROD 140mm	2-3 GRUPPI/2-3 GROUPS
19B	10112064	SONDA DI LIVELLO 120mmZOE 1GR	LEVEL CHECK ROD 120 mm ZOE 1 GR	1 GRUPPO/1 GROUP

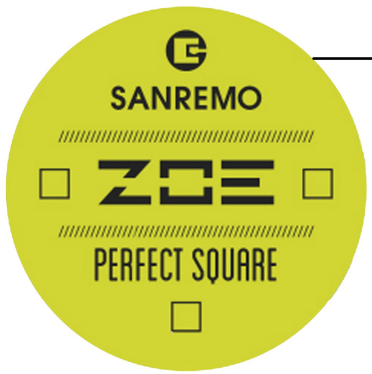

IMPIANTO IDRAULICO / HYDRAULIC SYSTEM

TAVOLA
DRAWING

4

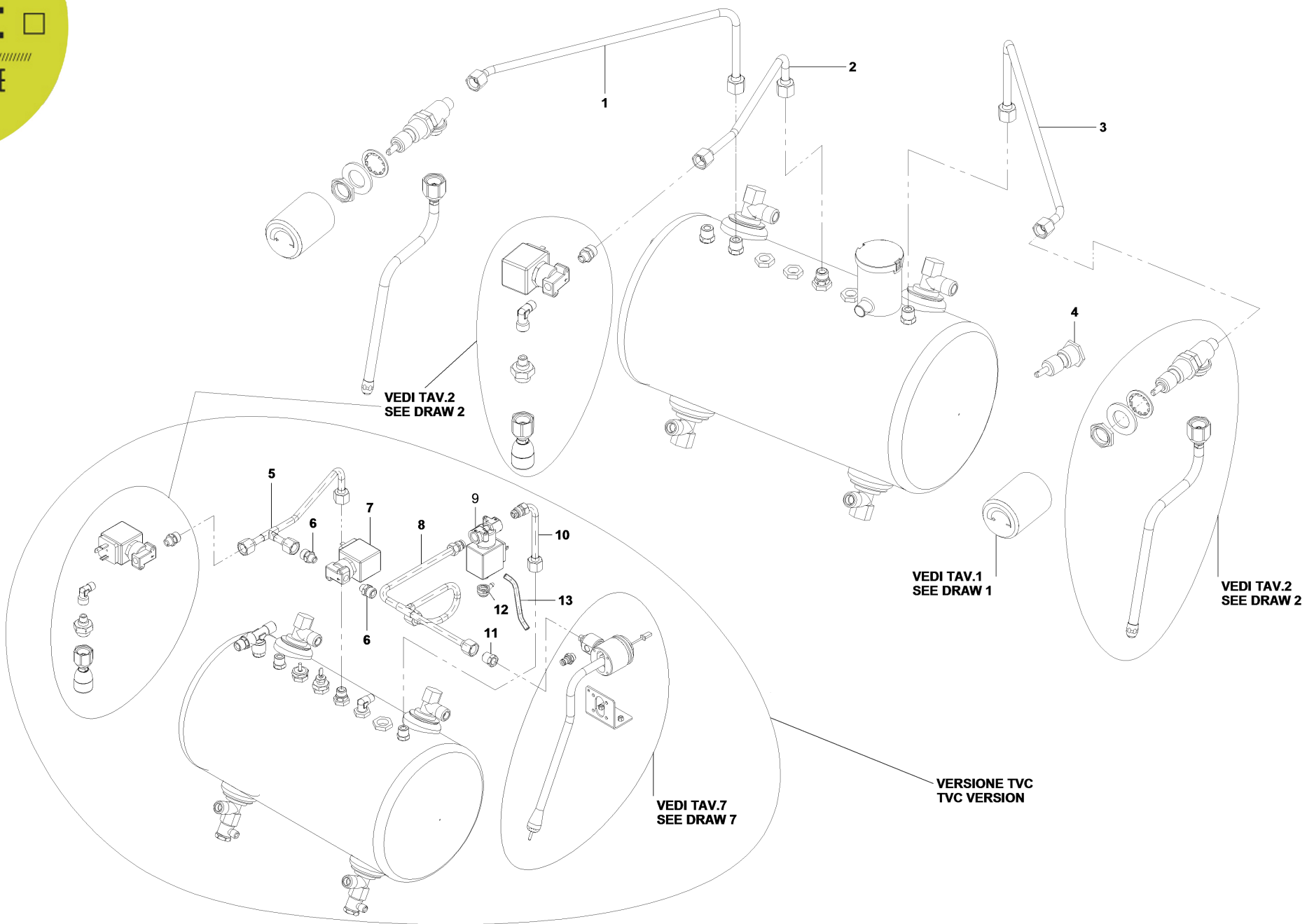

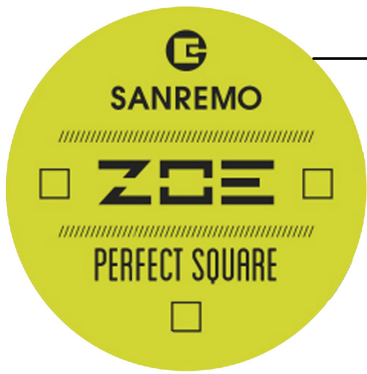

IMPIANTO IDRAULICO / HYDRAULIC SYSTEM

TAVOLA
DRAWING

4



RIF. POS	CODICE CODE	DESCRIZIONE	DESCRIPTION	NOTE NOTES
1	10003222	TUBO VAPORE SX ZOE 2-3GR	STEAM TUBE SX ZOE 2- 3 GR	2-3 GRUPPI / 2-3 GROUPS
2A	10003236	TUBO PRELIEVO ACQUA CALDA ZOE 1GR	HOT WATER INLET TUBE ZOE 1GR	1 GRUPPO/1 GROUPS
2B	10003226	TUBO PRELIEVO ACQUA CALDA ZOE 2GR	HOT WATER INLET TUBE ZOE 2GR	2 GRUPPI/2GROUPS
2C	10003284	TUBO PRELIEVO ACQUA CALDA ZOE 3GR	HOT WATER INLET TUBE ZOE 3GR	3 GRUPPI/3 GROUPS
3A	10003238	TUBO VAPORE DX ZOE 1GR	STEAM TUBE DX ZOE 1GR	1 GRUPPO/1 GROUP
3B	10003224	TUBO VAPORE DX ZOE 2 -3 GR	STEAM TUBE DX ZOE 2- 3 GR	2-3 GRUPPI / 2-3 GROUPS
4	10402035	RACCORDO FISSO MANOPOLA VAPORE	STEAM KNOB FITTING	
5A	10003212	TUBO PRELIEVO ACQUA COLLEGATO CON ELETTROVALVOLA LAVAGGIO E RUBINETTO ZOE 2GR TVC	WATER INJET TUBE CONNECTED EITH WASHING SOLENOID AND TAP ZOE 2 GR TVC	2 GRUPPI/2GROUPS TVC
5B	10003214	TUBO PRELIEVO ACQUA COLLEGATO CON ELETTROVALVOLA LAVAGGIO E RUBINETTO ZOE 3GR TVC	WATER INJET TUBE CONNECTED EITH WASHING SOLENOID AND TAP ZOE 3GR TVC	3 GRUPPI/3 GROUPS TVC
6	10857050B	RACCORDO 8-1/8" DRITTO M	STRAIGHT FITTING 8-1/8" 230V	
7	10303108	ELETTROVALVOLA 2 VIE 1/8" 230V	2 WAY SOLENOID 1/8" 230V	
8	10003216	TUBO COLLEGAMENTO LANCIA CON ELETTROVALVOLA VAPORE ZOE 2-3GR TVC	PIPE CONNECTION TUBE WITH STEAM SOLENOID 2-3 GR TVC	2-3 GRUPPI / 2-3 GROUPS TVC
9	10302070	ELETTROVALVOLA 3VIE 1/4X3,2 230V 50HZ	3 WAY SOLENOID 1/4X3.2 230V 50HZ	
10	10003210	TUBO PRELIEVO VAPORE ZOE 2-3GR TVC	STEAM INJET TUBE ZOE 2-3 GR TVC	2-3 GRUPPI / 2-3 GROUPS TVC
11	10857520C	RACCORDO RIDUZIONE 1/4M-1/8F	REDUCTION FITTING 1/4M—1/8F	
12	10255028A	RACCORDO GOMITO GIREVOLE	REVOLVING ANGLE FITTING	
13	10905010	TUBO SILICONE TRASPARENTE 7X4	TRASPARENT SILICON TUBE 7X4	

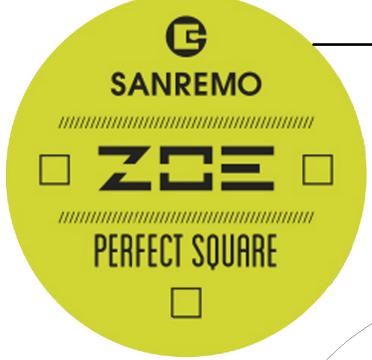

IMPIANTO IDRAULICO / HYDRAULIC SYSTEM

TAVOLA
DRAWING

5

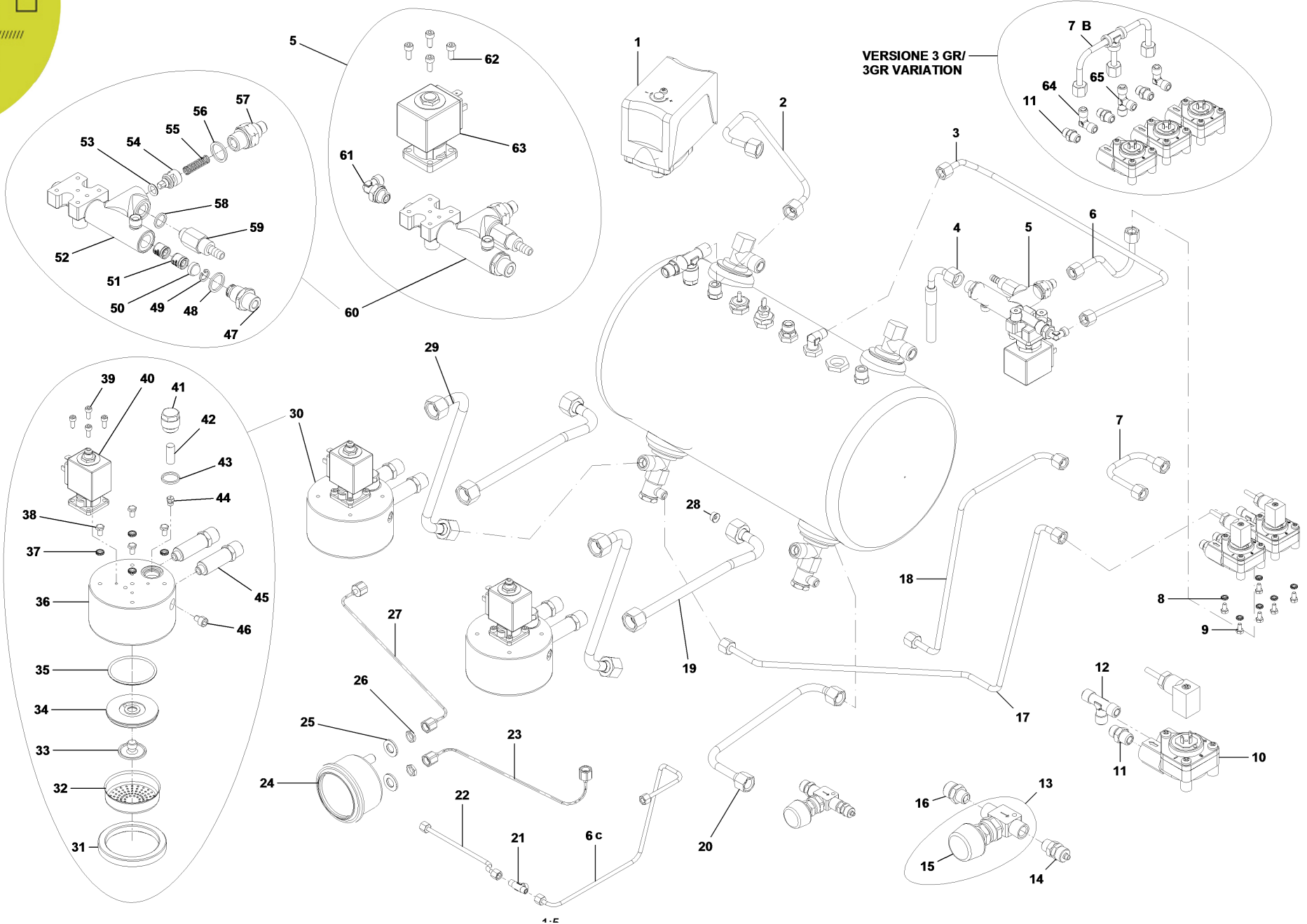

VERSIONE 3 GR/
3GR VARIATION

4-C

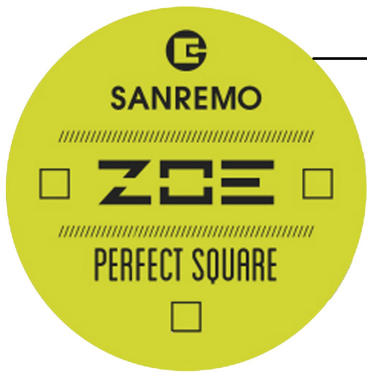

IMPIANTO IDRAULICO / HYDRAULIC SYSTEM

TAVOLA
DRAWING

5



RIF. POS	CODICE CODE	DESCRIZIONE	DESCRIPTION	NOTE	TES	NO-
1	10602010A	PRESSOSTATO	PRESSURE SENSOR		Colonna1	
2A	10003240	TUBO PRESSOSTATO ZOE 1GR	PRESSURE SENSOR TUBE ZOE 1 GR		1 GRUPPO/1 GROUP	
2B	10003220	TUBO PRESSOSTATO ZOE 2-3 GR	PRESSURE SENSOR TUBE ZOE 2-3 GR		2-3 GRUPPI/2-3 GROUPS	
3A	10003174	TUBO CARICO CALDAIA ZOE 1GR	BOILER LOADING TUBE ZOE 1GR		1 GRUPPO/1 GROUP	
3B	10003160	TUBO CARICO CALDAIA ZOE 2GR	BOILER LOADING TUBE ZOE 2GR		2 GRUPPI/2GROUPS	
3C	10003282	TUBO CARICO CALDAIA ZOE 3GR	BOILER LOADING TUBE ZOE 3GR		3 GRUPPI/3GROUPS	
4	10852470B	TUBO TRAZIONE 1/4 TD8-TD8 90° L. 450	TRACTION TUBE 1/4 TD8-TD8 90° L. 450			
5A	10056121A	ASSIEME MASSELLO 120V LIGHT 32X32	LIGHT FILL BLOCK ASSEMBLY 120V 32X32			
5B	10056110A	ASSIEME MASSELLO 230V LIGHT 32X33	LIGHT FILL BLOCK ASSEMBLY 230V 32X32			
6A	10003162	TUBO ALIMENTAZIONE VOLUMETRICO ZOE 2 GR SED	VOLUMETRIC SUPPLY TUBE ZOE 2 GR SED		1-2-3 GRUPPI/1-2-3GROUPS SED	
6B	10003178	TUBO ALIMENTAZIONE ZOE 1GR SAP	SUPPLY TUBE ZOE 1GR SAP		1 GRUPPO/1 GROUP SAP	
6C	10003170	TUBO ALIMENTAZIONE ZOE 2GR SAP	SUPPLY TUBE ZOE 2GR SAP		2 GRUPPI/2 GROUPS SAP	
6D	10003294	TUBO ALIMENTAZIONE ZOE 3GR SAP	SUPPLY TUBE ZOE 3GR SAP		3 GRUPPI/3GROUPS SAP	
7A	10002060	TUBO PONTE 1° - 2° VOLUMETRICO ZOE 2 GR	VOLUMETRIC BRIDGE TUBE 1° - 2° ZOE 2GR		2 GRUPPI/2GROUPS SED	
7B	10003292	TUBO PONTE 1° - 2°- 3° VOLUMETRICO ZOE 3 GR	VOLUMETRIC BRIDGE TUBE 1° - 2°- 3° ZOE 3GR		2-3 GRUPPI/2-3 GROUPS SED	
8	10803519	RONDELLA D 4,2 DENTATA	TOOTHED WASHER D 4,2			
9	10805074	VITE TE M4X8	SCREW TE M4X6			
10	10112290A	CONTATORE VOLUMETRICO	VOLUMETRIC COUNTER			
11	10857080A	RACCORDO DRITTO 6- 1/8" M	STRAIGHT FITTING 6 -1/8"			
12	10857028A	RACCORDO T 6-6 1/8" M	FITTING T 6 1/8" M			
13	10402059	RUBINETTO SCARICO CON MANOPOLA	DRAIN TAP WITH CONTROL KNOB			
14	10853058A	RACCORDO DRITTO PORTAGOMMA 6/4—1/8" M	NOZZLE HOSE STRAIGHT FITTING 6/4—1/8" M			
15	10402060	MANOPOLA RUBINETTO SCARICO	CONTROL KNOB DRAIN TAP			
16	10857050B	RACCORDO 8-1/8" DRITTO	STRAIGHT JOINT 8-1/8"			
17A	10003176	TUBO ALIMENTAZIONE GR ZOE 1GR	SUPPLY TUBE GR ZOE 1GR		1 GRUPPO/1 GROUP	
17B	10003166	TUBO ALIMENTAZIONE 1°GR ZOE 2GR	SUPPLY TUBE 1° GR ZOE 2GR		2 GRUPPI/2GROUPS	
17C	10003286	TUBO ALIMENTAZIONE 1°GR ZOE 3GR	SUPPLY TUBE 1° GR ZOE 3GR		3 GRUPPI/3GROUPS	

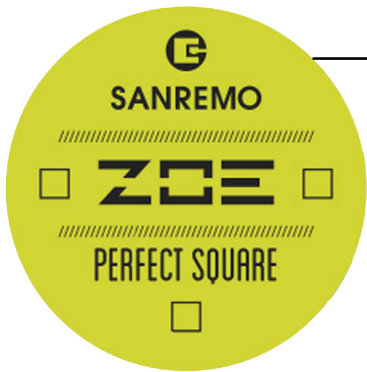

IMPIANTO IDRAULICO / HYDRAULIC SYSTEM

TAVOLA
DRAWING

5



RIF. POS	CODICE CODE	DESCRIZIONE	DESCRIPTION	NOTE NOTES
18A	10003168	TUBO ALIMENTAZIONE 2° GR ZOE 2GR	SUPPLY TUBE 2° GR ZOE 2GR	2 GRUPPI/2GROUPS
18B	10003288	TUBO ALIMENTAZIONE 2° GR ZOE 3GR	SUPPLY TUBE 2° GR ZOE 3GR	3 GRUPPI/3GROUPS
18C	10003290	TUBO ALIMENTAZIONE 3° GR ZOE 3GR	SUPPLY TUBE 3° GR ZOE 3GR	3 GRUPPI/3GROUPS
19A	10003060	TUBO SCAMBIATORE SUPERIORE ZOE 1GR	UPPER EXCHAGER TUBE ZOE 1GR	1 GRUPPO/1 GROUP
19B	10003050	TUBO SCAMBIATORE SUPERIORE ZOE 2-3 GR	UPPER EXCHAGER TUBE ZOE 2-3 GR	2-3 GRUPPI/2-3 GROUPS
20	10003228	TUBO DI SCARICO CALDAIA ZOE 1-2-3 GR	BOILER DRAIN TUBE ZOE 1-2-3 GR	1-2-3 GRUPPI/1-2-3GROUPS
21	10857780A	RACCORDO T 1/8" M/F/M	FITTING T 1/8" M/F/ M	2 GRUPPI/2 GROUPS 2 GRUPPI/2 GROUPS
22	10003172	TUBO PONTE 1°-2°GR	BRIDGE TUBE 1°-2° GR	SAP
23	10002021	TUBO CAPILLARE	HAIRLINE TUBE	
24	10552018A	MANOMETRO DOPPIA SCALA D60	DOUBLE RANGE GAUGE D60	
25	10852200	RONDELLA D10,5X20X2	WASHER D10,5X20X2	
26	10853085	DADO ESAGONALE 1/8"	HEXAGONAL NUT 1/8"	
27A	10002028	TUBO CAPILLARE PRESSOSTATO CALDAIA	PRESSURE SENSOR HAIRLINE TUBE	
27B	10002030	TUBO CAPILLARE PRESSOSTATO CALDAIA ZOE 3 GR	PRESSURE SENSOR HAIRLINE TUBE ZOE 3 GR	3 GRUPPI/3 GROUPS
28A	10052174A	GIGLEUR FORO D 2,5	GIGLEUR HOLE D 2,5	
28B	10052176A	GIGLEUR FORO D 3	GIGLEUR HOLE D 3	
28C	10052178A	GIGLEUR FORO D 3,5	GIGLEUR HOLE D 3,5	
28D	10052179A	GIGLEUR FORO D 2	GIGLEUR HOLE D 2	
29A	10003062	TUBO SCAMBIATORE INFERIORE ZOE 1GR	LOWER EXCHAGER TUBE ZOE 1GR	1 GRUPPO/1 GROUP
29B	10003052	TUBO SCAMBIATORE INFERIORE ZOE 2GR	LOWER EXCHAGER TUBE ZOE 2GR	2 GRUPPI/2GROUPS
29C	10003280	TUBO SCAMBIATORE INFERIORE ZOE 3GR	LOWER EXCHAGER TUBE ZOE 3GR	3 GRUPPI/3GROUPS
30A	10052208C	GRUPPO EROGAZIONE 120V	DISTRIBUTION GROUP 120V	
30B	10052206C	GRUPPO EROGAZIONE 230V	DISTRIBUTION GROUP 230V	
31	10502110	GUARNIZIONE SOTTOCOPPA H8,2mm	UNDER CUP SEAL H8,2mm	
32	10052120	DOCCIA RETE GRUPPO	GROUP NET SHOWER	
33	10052141A	DIFFUSORE GRUPPO	GROUP DIFFUSER	
34	10052248B	MAZZOCCO GRUPPO	GROUP MAZZOCCO	
35	10502070A	OR 3187 PER MAZZOCCO	MAZZOCCO OR 3187	
36	10052028C	GRUPPO EROGAZIONE ANELLO	RING DISTRIBUTION GROUP	

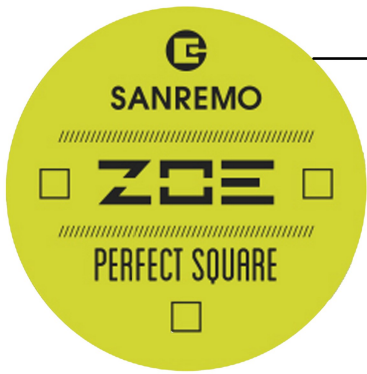

IMPIANTO IDRAULICO / HYDRAULIC SYSTEM

TAVOLA
DRAWING

5



RIF. POS	CODICE CODE	DESCRIZIONE	DESCRIPTION	NOTE NOTES
37	10803520	RONDELLA DENTATA D5,3	TOOTHED WASHER D5,3	
38	10805075	VITE TE M5X8	SCREW TE M5X8	
39	10805071	VITE TCEI M4X10 A3	SCREW TCEI M4X10 A3	
40A	10305555A	ELETTROVALVOLA 3 VIE 32X32 120V	3 WAY SOLENOID 32X32 120V	
40B	10302096	ELETTROVALVOLA 3 VIE 32X32 230V	3 WAY SOLENOID 32X32 230V	
41	10052142	TAPPO CHIUSURA GIGLEUR	GIGLEUR CAP	
42	10052136	FILTRO GRUPPO ANELLO	FILTER RING GROUP	
43	10052143	GUARNIZIONE TAPPO	SEAL CAP	
44	10052135A	GIGLEUR GRUPPI	GIGLEUR GROUPS	
45	14852032A	PROLUNGA L.61 GRUPPO ANELLO	RING GROUP EXTENCION L61	
46	10805078	VITE TCEI M6X8 A2	SCREW TCEI M6X8 A2	
47	10058044A	RACCORDO 1/4" - 1/4" ALIMENTAZIONE MASSELLO	FILL BLOCK SUPPLY JOINT 1/4" - 1/4"	
48	10058050	RONDELLA RAME 1/4" MASSELLO	FILL BLOCK COPPER WASHER 1/4"	
49	10806288	ANELLO SEEGER	CIRCLIP	
50	10355172	FILTRO A RETE TONDO	CIRCULAR NET FILTER	
51	10652052	VALVOLA ANTIRIFLUSSO	ANTI-BLACKFLOW VALVE	
52	10056058E	CORPO MASSELLO LIGHT	FILL BLOCK BODY	
53	10402068	OR 106 NBR	OR 106 NBR	
54	10058027A	PISTONCINO MASSELLO	BODY VALVE PISTON	
55	10053110	MOLLA VALVOLA MASSELLO	BODY VALVE SPRING	
56	10053109	RONDELLA RAME VALVOLA	COPPER WASHER VALVE	
57	10058042A	NIPLESS VALVOLA MASSELLO	NON RETURN VALVE	
58	10058048	RONDELLA RAME 1/8"	COPPER WASHER 1/8"	
59	10655557B	VALVOLA ESPANSIONE	EXPANSION VALVE	
60	10056058E	CORPO MASSELLO LIGHT	FILL BLOCK BODY	
61	10255058	RACCORDO GOMITO GIREVOLE 1/8 OGIVA D6	REVOLVING ELBOW JOINT 1/8 OGIVE D6	
62	10805071	VITE TCEI M4X10 A2	SCREW TCEI M4X10 A2	
63A	10303100	ELETTROVALVOLA 2 VIE 32X32 120V	2 WAY SOLENOID 32X32 120V	
63B	10302100	ELETTROVALVOLA 2 VIE 32X32 230V	2 WAY SOLENOID 32X32 230V	
64	10857030A	RACCORDO GOMITO 6-1/8" M	ANGLEJOINT 6-1/8" M	3 GRUPPI / 3 GROUPS
65	10857630A	RACCORDO T 6-1/8"-6 M/M/M	JOINT T 6-1/8"-6 M/M/M	3 GRUPPI / 3 GROUPS

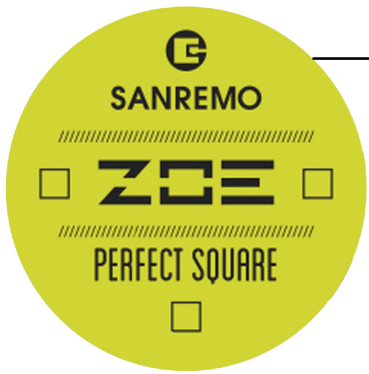

GRUPPO EROGAZIONE / DISTRIBUTION GROUP

TAVOLA
DRAWING

6

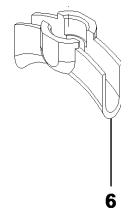
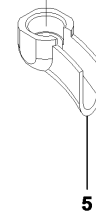
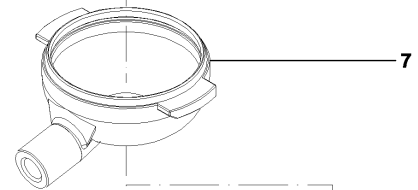
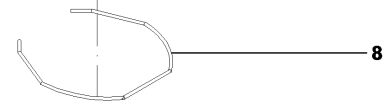
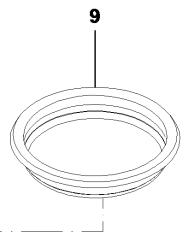
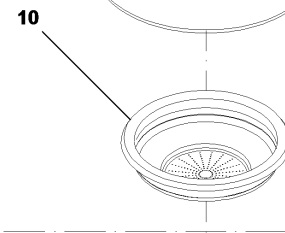
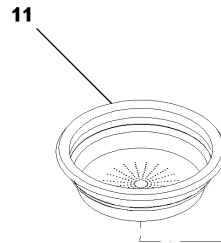
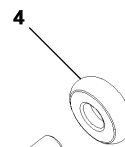
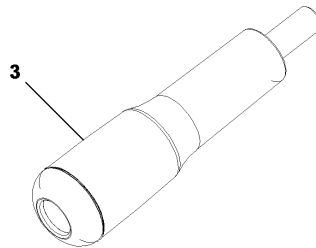
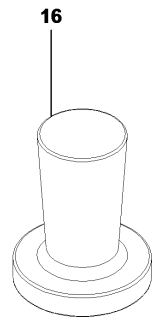
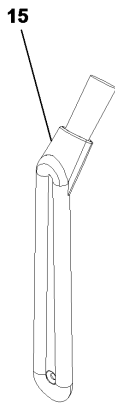
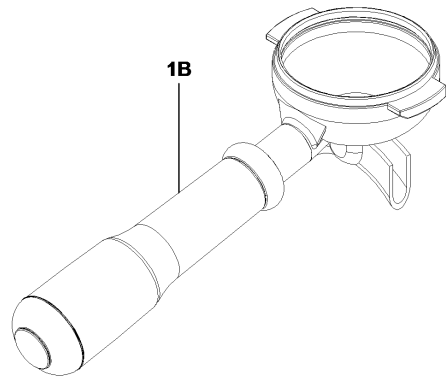
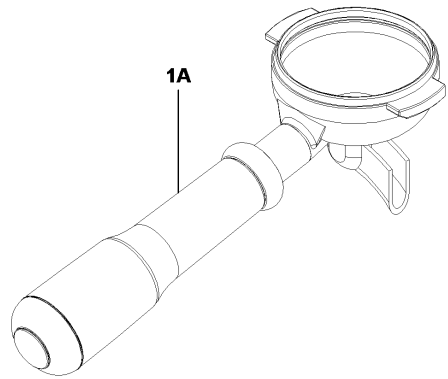
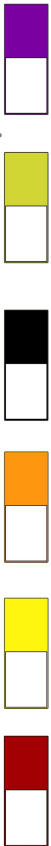

VEDI TAV.5
SEE DRAW 5

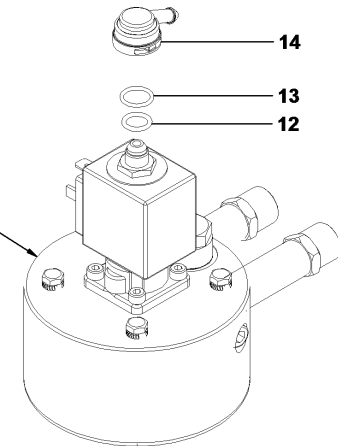

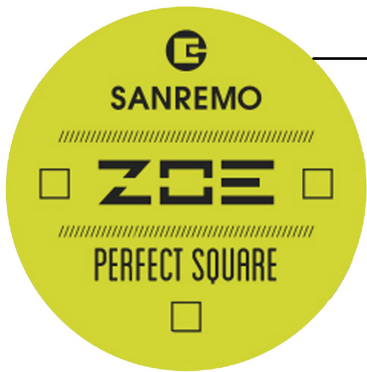

GRUPPO EROGAZIONE / DISTRIBUTION GROUP

TAVOLA
DRAWING

6

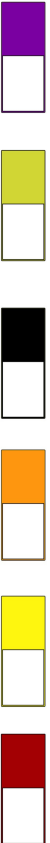

RIF. POS	CODICE CODE	DESCRIZIONE	DESCRIPTION	NOTE NOTES
1A	10402310C	ASSIEME PORTAFILTRO 1TZ	1 CUP FILTERHOLDER ASSEMBLY	
1B	10402312B	ASSIEME PORTAFILTRO 2TZ	2 CUP FILTERHOLDER ASSEMBLY	
1C	10402362	ASSIEME PORTAFILTRO 1TZ MAGGIORATO	INCREASED 1 CUP FILTERHOLDER ASSEMBLY	
1D	10402368	ASSIEME PORTAFILTRO 2 TZ MAGGIARATO	INCREASED 2 CUP FILTERHOLDER ASSEMBLY	
2	10091152	TAPPO MANICO PORTAFILTRO	FILTERHOLDER CAP	
3	10091150A	MANICO PORTAFILTRO CON TAPPO	FILTERHOLDER HANDLE WITH TOP	
4	10091154	ANELLO MANICO PORTAFILTRO	FILTERHOLDER RING HANDLE	
5	14052075A	BECCUCCIO 1 VIA APERTO	1 WAY OPEN NOZZLE	
6A	14052085A	BECCUCCIO 2 VIE APERTO	2 WAY OPEN NOZZLE	
6B	14052090	BECCUCCIO 2 VIE MAGGIORATO	INCREASED 2 WAY NOZZLE	MAGGIORATO /INCREASED
7A	14052034	CORPO PORTAFILTRO INCLINATO	INCLINED FILTERHOLDER BODY	
7B	14402328	CORPO PORTAFILTRO MAGGIORATO	INCREASED FILTERHOLDER BODY	MAGGIORATO /INCREASED
8A	10052051	MOLLA FERMA FILTRO D 1,2	STOP FILTER SPRING	
8B	10052050	MOLLA FERMAFILTRO MAGGIORATO	INCREASED STOP FILTER SPRING	MAGGIORATO /INCREASED
9	10052220	FILTRO CIECO D8 H3	BLIND FILTER D8 H3	
10A	10052072	FILTRO 1 TAZZA	1CUP FILTER	
10B	10052100	FILTRO 1 TAZZA MAGGIORATO	INCREASER 1 CUP FILTER	MAGGIORATO /INCREASED
11A	10052074	FILTRO 2 TAZZE	2 CUP FILTER	
11B	10052084	FILTRO 2 TAZZE MAGGIORATO	INCREASED 2 CUP FILTER	MAGGIORATO /INCREASED
12	10505071	OR 2018 D 4,48mm	OR 2018 D 4,48mm	
13	10505079	OR EPDM	OR EPDM	
14	10255028A	RACCORDO GOMITO GIREVOLE	REVOLVING ELBOW JOINT	
15	10052020	SPAZZOLINO	SMALL BRUSH	
16	PA051640A	PRESSINO	TAMPER	

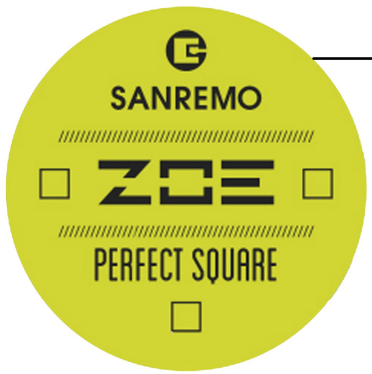

CARICO-SCARICO ACQUA / WATER CHARGE - DISCHARGE

TAVOLA
DRAWING

7

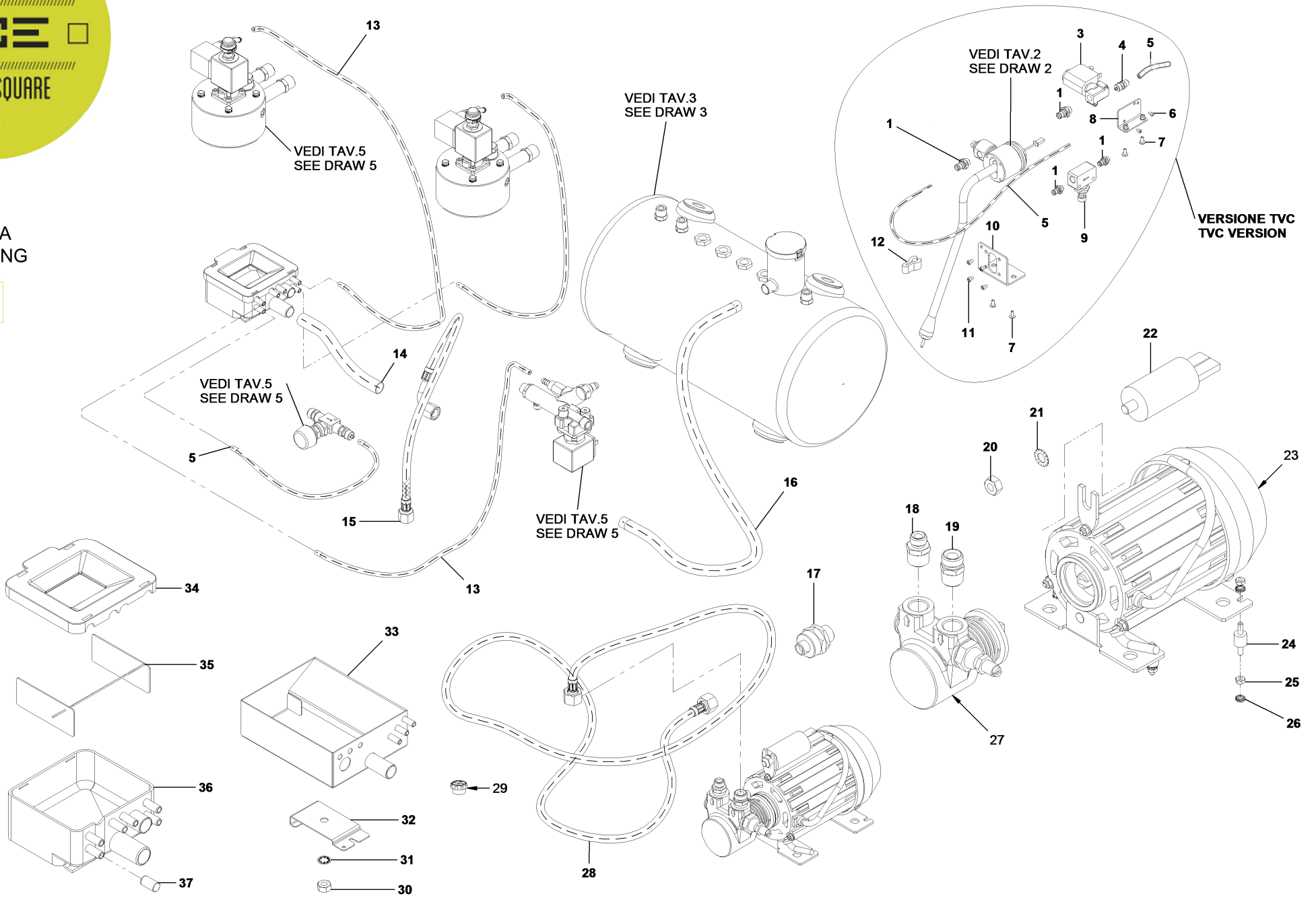



CARICO-SCARICO ACQUA / WATER CHARGE - DISCHARGE

TAVOLA DRAWING

7

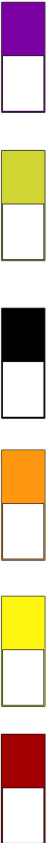

RIF. POS	CODICE CODE	DESCRIZIONE	DESCRIPTION	NOTE	TES	NO-
1	10853204	RACCORDO RAPIDO DRITTO 4X1/8M CON OR	RAPID STRIGHT FITTING 4X1/8M WITH OR			
3	10303010B	ELETTROVALVOLA 2VIE 1/8"D1,5 230V	2 WAY SOLENOID 1/8" D1,5 230V			
4	10853058	RACCORDO DRITTO 6/4 - 1/8"M	STRIGHT FITTING 6/4 -1/8"M			
5	10909010	TUBO D4X1,5 TEFLON	TEFLON TUBE D4X1,5			
6	10805126	VITE TC + M3X6	SCREW TC + M3X6			
7	10805027A	VITE TBL + M4X10	SCREW TBL +M4X10			
8	10017852	STAFFA SUPPORTO ELETTROVALVOLA TVC ZOE	SOLENOID SUPPORT CLAMP ZOE TVC			TVC
9	10852004	REGOLATORE DI FLUSSO	FLOW CONTROL			
10	10017860	STAFFA SUPPORTO LANCIA TVC ZOE	PIPE SUPPORT CLAMP TVC ZOE			TVC
11	10805060	VITE TCEI M4X6	SCREW TCEI M4 X6			
12	10753056	GOMMINO ANTISCIVOLO	NO SLIP RUBBER			
13	10905010	TUBO SILICONE TRASPARENTE 7X4 1-2-3 GR	TRASPARENT SILICON TUBE 7X4 1-2-3 GR			1-2-3- GRUPPI/ 1-2-3 GROUPS
14	10852460	TUBO SPIRALATO SCARICO D16X22 L.2 MT	SPIREAL EXHAUST TUBE D 16X22 L,2MT			
15	10852470B	TUBO TRAZAZIONE 1/4 TD8-TD8 90° L.450	TRACTION TUBE 1/4 TD8/TD8 90° L.450			
16	10905024	TUBO SILICONE D12X18	SILICON TUBE D12X18			
17	10355150A	FILTRO POMPA	PUMP FILTER			
18	10857293B	RACCORDO DRITTO 8-3/8"M	STRAIGHT FITTING 8-3/8"M			
19	10857290B	RACCORDO DRITTO 10-3/8" M	STRAIGHT FITTING 10-3/8"M			
20	10802500	DADO 8MA	NUZZLE 8MA			
21	10803538	RONDELLA D8,2 DENTATA	TOOTHED WASHER D 8,2			
22A	10252038	CONDENSATORE 6MF 450VL MOTORE POMPAP.150W 230V	CONDENSER 6MF 450VL PUMP MOTOR 150W 230V			
22B	10252040	CONDENSATORE 10 MF 450VL MOTORE POMPA.165W 23	CONDENSER 10MF 450VL PUMP MOTOR 165W 230V			
23A	10252079A	MOTORE ELETTRICO 150WATT 120V	ELECTRICAL MOTOR 150WATT 120V			1-2 GRUPPI/ 1-2 GROUPS
23B	10252094B	MOTORE ELETTRICO 150W 230V	ELECTRICAL MOTOR 150WATT 230V			3 GRUPPI / 3 GROUPS
23C	10252098B	MOTORE ELETTRICO.130W 230V	ELECTRICAL MOTOR 130WATT 230V			1-2 GUPPI / 1-2 GROUPS
24	10255022	ANTIVIBRANTE PUFFER D10X10 M4XH10	ANTIVIBRATION PUFFER D10X10 M4XH10			
25	10805512	DADO 4MA	NUZZLE 4MA			

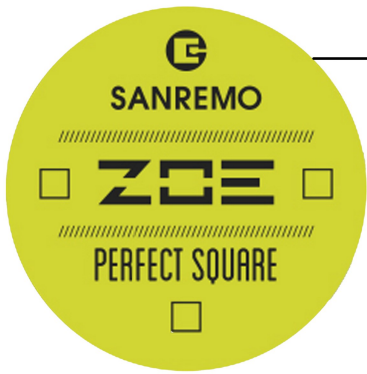

CARICO-SCARICO ACQUA / WATER CHARGE - DISCHARGE

TAVOLA DRAWING

7

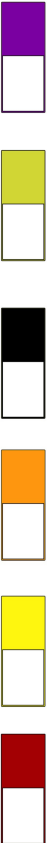

RIF. POS	CODICE CODE	DESCRIZIONE	DESCRIPTION	NOTE NOTES
26	10803519	RONDELLA D4,2 DENTATA	TOOTHED WASHER D 4,2	
27A	10252070C	POMPA ROTATIVA 150L 1-2GR	ROTARY PUMP 150L 1-2GR	1-2 GRUPPI/1-2 GROPUS
27B	10252072C	POMPA ROTATIVA 204L 2-3GR	ROTARY PUMP 204L 2-3GR	2-3 GRUPPI/ 2-3 GROUPS
28	10852484B	TUBO TRAZIONE 3/8 FD-FD L=2000	TRACTION TUBE 3/8 FD-FD L2000	
29	10351134	TAPPO LDPE TRASPARENTE PER TUBO TRAZIONE	LDPE TRASPARENT TOP FOR TRACTION TUBE	
30	10802500	DADO 8MA	NUZZLE 8MA	
31	10803521	RONDELLA D8,2 DENTATA	TOOTHED WASHER D8,2	
32	10017848A	STAFFA SUPPORTO VASCHETTA SCARICO	DRAIN BOX SUPPORT CLAMP	
33	10022461B	VASCHETTA SCARICO INOX	INOX DRIN BOX	
34	10022476B	COPERCHIO VASCHETTA DI SCARICO	DRAIN BOX COVER	
35	10012144	ROMPIGETTO PER VASCHETTA SCARICO	JET BREAKER FOR DRAIN TUBE	
36	10022441A	VASCHETTA SCARICO	DRAIN BOX	
37	10052064	TAPPO VASCHETTA DI SCARICO	DRAIN BOX TOP	

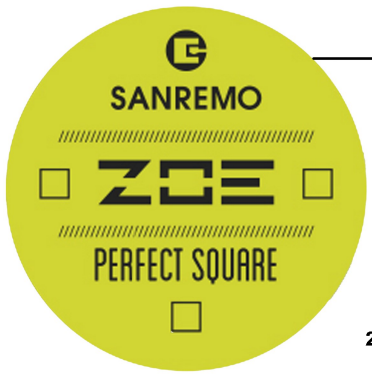

IMPIANTO ELETTRICO / ELECTRICAL SYSTEM

TAVOLA
DRAWING

8

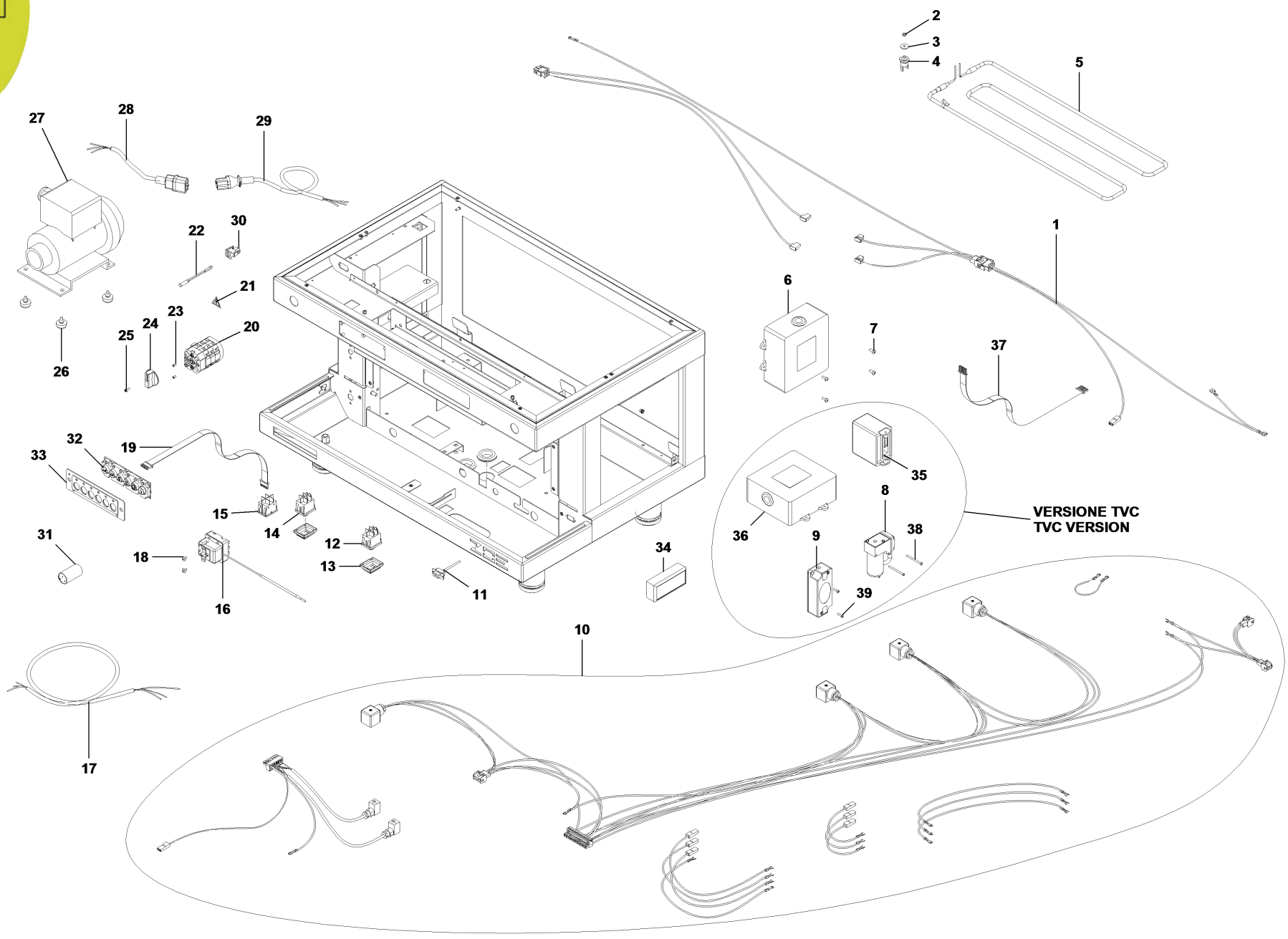

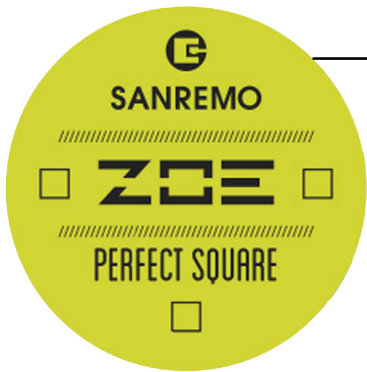

IMPIANTO ELETTRICO / ELECTRICAL SYSTEM

TAVOLA
DRAWING

8



RIF. POS	CODICE CODE	DESCRIZIONE	DESCRIPTION	NOTE	NOTES
1	10102566	CABLAGGIO SCALDATAZZE ZOE 2-3GR	WIRING CUPWARMER	2-3 GRUPPI/ 2-3 GROUPS	
2	10805512	DADO M4 MEDIO	MIDDLE NUT M4	2-3 GRUPPI/ 2-3 GROUPS	
3	10803519	RONDELLA D 4,2 DENTATA	SERRATED WASHER D 4,2	2-3 GRUPPI/ 2-3 GROUPS	
4	10111007	TERMOSTATO 70° PER RESISTENZA SCALDATAZZE	THERMOSTAT 70° FOR CUPWARMER ELECTRICAL RESISTANCE	2-3 GRUPPI/ 2-3 GROUPS	
5A	10455122A	RESISTENZA SCALDATAZZE 2GR 230V 200W D 6,4	CUPWARMER ELECTRICAL RESISTANCE 2GR 230V 200W D 6,4	2 GRUPPI/ 2 GROUPS	
5B	10455123A	RESISTENZA SCALDATAZZE 3GR 230V 250W D 6,4	CUPWARMER ELECTRICAL RESISTANCE 3GR 230V 250W D 6,4	3 GRUPPI/ 3 GROUPS	
6A	10112012	CENTRALINA 3D5 1-2-3GRCT XLC 120V SED	ELECTRICAL JUNCTION BOX 3D5 1-2-3 GRCT XLC 120V SED	1-2-3 GRUPPI/ 1-2-3 GROUPS SED	
6B	10112072F	CENTRALINA 3D5 3GRCT XLC 1-2-3GR 230V SED MODELLO LED	ELECTRICAL JUNCTION BOX 3D5 1-2-3 GRCT 230V SED LED MODEL	1-2-3 GRUPPI/ 1-2-3 GROUPS SED MODELLO LED	
6C	10112113	CENTRALINA ON-OFF 1-2-3 GR XLC 230V SAP	ON - OFF ELECTRICAL BOX 1-2-3 GR XLC 230V SAP	1-2-3 GRUPPI/ 1-2-3 GROUPS SAP	
6D	10112163	CENTRALINA ON-OFF 1-2-3 GR XLC 120V SAP	ON - OFF ELECTRICAL BOX 1-2-3 GR XLC 230V SAP	1-2-3 GRUPPI/ 1-2-3 GROUPS SAP	
7	10805084	VITE TC+ M4X10	SCREW TC+ M4X10		
8	10255084	COMPRESSORE A PISTONE 12V	PISTON COMPRESSOR 12V	TVC	
9	10554112	ALIMENTATORE 230/12V 12W	POWER PACK 230/12V 12W	TVC	
10A	10102564B	CABLAGGIO ZOE 1GR SED CON GUAINA	WIRING ZOE 1GR SED IN TROUBLE	1 GRUPPO/ 1 GROUP	SED
10B	10102568A	CABLAGGIO ZOE 1GR SAP INGUAINATO COMPLETAMENTE NO FLAME	WIRING ZOE 1GR SAP TOTALLY IN TROUBLE NO FLAME	1 GRUPPO/ 1 GROUP	SAP
10C	10102560B	CABLAGGIO ZOE 2GR SED INGUAINATO NO FLAME	WIRING ZOE 2GR SED IN TROUBLE NO FLAME	2 GRUPPI/ 2 GROUPS	SED
10E	10102570C	CABLAGGIO ZOE 2GR SAP INGUAINATO NO FLAME	WIRING ZOE 2GR SAP IN TROUBLE NO FLAME	2GRUPPI/ 2 GROUPS	SAP
10F	10102562A	CABLAGGIO ZOE 3GR SED INGUAINATO NO FLAME	WIRING ZOE 3GR SED IN TROUBLE NO FLAME	3GRUPPI/ 3 GROUPS	SED
10G	10102572A	CABLAGGIO ZOE 3GR SAP INGUAINATO NO FLAME	WIRING ZOE 3GR SAP IN TROUBLE NO FLAME	3GRUPPI/ 3 GROUPS	SAP
10H	10102588A	CABLAGGIO ZOE TVC 2 GR	WIRING ZOE TVC 2 GR	2 GRUPPI / 2 GROUPS	TVC
10I	10102594	CABLAGGIO ZOE TVC 3GR	WIRING ZOE TVC 3GR	3GRUPPI / 3 GROUPS	TVC
11	10112105	CAVO U SERIALE	SERIAL CABLE U		
12	10111054	INTERRUTTORE BIP	BIP SWITCH		
13	10105243B	CAPPUCCIO INTERRUTTORE	CUP SWITCH		
14	10556041A	INTERRUTTORE BIP LUMINOSO ROSSO SCALDATAZZE	CUPWARMER RED BRIGHT BIP SWITCH		
15	10556045	TAPPO CIECO 22X30 NERO	BLACK BLIND CAP		
16	10111015	TERMOSTATO 169° TRIFASE	THERMOSTAT 169° THREE-PHASE		

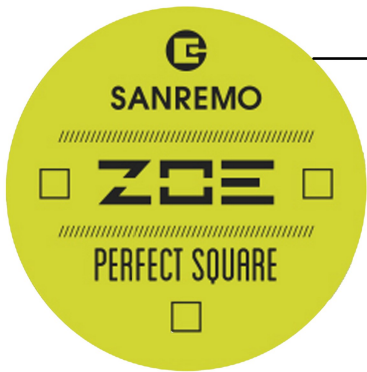

IMPIANTO ELETTRICO / ELECTRICAL SYSTEM

TAVOLA
DRAWING

8

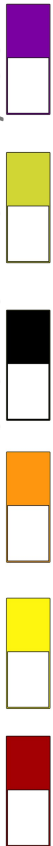

RIF. POS	CODICE CODE	DESCRIZIONE	DESCRIPTION	NOTE NOTES
17A	10102190	CAVO ALIMENTAZIONE 3X2,5 MT 3 N5	SUPPLY CABLE 3X2,5 MT 3 N5	1-2 GRUPPI/ 1-2 GROUPS
17B	10102191	CAVO ALIMENTAZIONE 5X2,5 MT 3 N4	SUPPLY CABLE 5X2,5 MT 3 N4	1-2-3 GRUPPI/ 1-2-3 GROUPS
17C	10102193	CAVO ALIMENTAZIONE 3X4 MT 3 N7	SUPPLY CABLE 3X4 MT 3 N7	2-3 GRUPPI/ 2-3 GROUPS
17D	10102196	CAVO 3X12 AWG 3MT	CABLE 3X12 AWG 3MT	1-2-3 GRUPPI/ 1-2-3 GROUPS
17E	10102197	CAVO 3X14 AWG 3MT	CABLE 3X14 AWG 3MT	1-2 GRUPPI/ 1-2 GROUPS
18	10805872	VITE TC+ M4X6	SCREW TC+ M4X6	
19A	10112078	CAVO PIN TO PIN 600mm 8X2 VIE	PIN TO PIN CABLE 600mm 8X2 WAY	1-2-3 GRUPPI/ 1-2-3 GROUPS
19B	10112079	CAVO PIN TO PIN 800mm 8X2 VIE	PIN TO PIN CABLE 800mm 8X2 WAY	2-3 GRUPPI/ 2-3 GROUPS
19C	10112067	CAVO PIN TO PIN 1100mm 8X2 VIE 3 GR	PIN TO PIN CABLE 1100 mm 8X2 WAY 3GR	3 GRUPPI/3 GROUPS
20A	10122050A	COMMUTATORE PONTE MONOFASE	BRIDGE COMMUTATOR SINGLE-PHASE	
20B	10122060A	COMMUTATORE PONTE TRIFASE	BRIDGE COMMUTATOR THREE-PHASE	
21	10955015	ETICHETTA SIMBOLO TENSIONE	HIGH VOLTAGE SYMBOL LABEL	
22A	10553024	SPIA ARANCIO D6 120V	ORANGE CONTROL LIGHT D6 120V	
22B	10553021	SPIA ARANCIO D6 230V	ORANGE CONTROL LIGHT D6 230V	
23	10805038	VITE TSP+ M3X6	SCREW TSP + M3 X6	
24	10122015	MANOPOLA PER COMMUTATORE	KNOB COMMUTATOR	
25	10805116	VITE TC+ M3X10 NERA	SCREW TC+ M3X10 BLACK	
26	10352058	PIEDINO NERO POMPA ESTERNA	EXTERNAL PUMP BLACK FOOT	POMPA ESTERNA/EXTERNAL PUMP
27	10252099	MOTORE ELETTRICO 150W 230V	ELECTRICAL MOTOR 150W 230V	
28A	10102597	CAVO COLLEGAMENTO MOTORE	CONNECTION CABLE MOTORS	
28B	10112105	CAVO U SERIALE	SERIAL U CABLE	
29	10102699	CAVO POMPA ESTERNA	EXTERNAL PUMP CABLE	
30	10105180A	BLOCCHETTO 2 VIE	2 WAY BLOCK	
31	10252016A	FILTRO CONDENSATORE	CONDENSER FILTER	
32A	10112268C	PULSANTIERA ZOE SED 6 TASTI	BUTTON ZOE SED 6 KEYS	SED
32B	10112274A	PULSANTIERA ZOE SAP 2 TASTI	BUTTON ZOE SAP 2 KEYS	SAP
33A	10017412A	SUPPORTO PULSANTIERA ZOE SED NERO OPACO	BUTTON SUPPORT ZOE SED MATT BLACK	SED
33B	10017414A	SUPPORTO PULSANTIERA ZOE SED BIANCO	BUTTON SUPPORT ZOE SED WHITE	SED
33C	10017432A	SUPPORTO PULSANTIERA ZOE SAP NERO OPACO	BUTTON SUPPORT ZOE SAP MATT BLACK	SAP
33D	10017434A	SUPPORTO PULSANTIERA ZOE SAP BIANCO	BUTTON SUPPORT ZOE SAP WHITE	SAP
34	10112342	SCHEDA BLUETOOTH	BLUETOOTH CARD	TVC
35	10112186A	CENTRALINA SCHEDA ESPANSIONE RELE'	RELE' EXPANSION BOARD ELECTRICAL JUNCTION BOX ZOE TVC	TVC

