



USER'S MANUAL
Translation of original instructions



BlueDot

CONTENTS

1 GENERAL SAFETY WARNINGS.....	5	5 TECHNICAL CHARACTERISTICS.....	49
2 IDENTIFICATION	8	5.1 TECHNICAL DATA.....	49
3 INTRODUCTION	9	5.2 OVERALL DIMENSIONS.....	50
3.1 SYMBOLS	9	6 RESIDUAL RISKS.....	50
3.2 USER TYPES	9	7 HANDLING AND STORAGE.....	51
3.3 INTENDED USE	10	8 INSTALLATION AND STARTUP	52
3.3.1 Reasonably foreseeable misuse	10	8.1 PACKAGING CONTENTS.....	52
4 DESCRIPTION OF THE MACHINE	11	8.2 PRIOR CHECKING AFTER RECEIPT	52
4.1 MACHINE CONFIGURATIONS ...	11	8.3 POSITIONING	53
4.2 OUTER COMPONENTS	13	8.4 INSTALLATION.....	54
4.3 INNER COMPONENTS.....	14	8.4.1 Power mains connection	54
4.3.1 Product containers.....	20	8.4.2 Water mains connection	55
4.3.2 Reduced inlet for containers	20	8.4.3 Milk circuit connection	55
4.4 TFT DISPLAY	21	9 INSTRUCTIONS FOR USE	57
4.4.1 Power ON - Switching on ...	21	9.1 GETTING STARTED	57
4.4.2 Heating waiting screen (Boiler-exchanger).....	22	9.1.1 Water tank filling	57
4.4.3 Introduction.....	22	9.1.2 Product filling	58
4.4.4 Selection of beverages to be dispensed (example of beverages) (free vend)	23	9.2 SWITCHING ON.....	59
4.4.5 Hot water delivery	24	9.3 DRINK DISPENSING	60
4.4.6 Dispensing in process	24	9.3.1 Boiler filling	60
4.4.7 Delivery completed	25	9.3.2 Dispensing circuit washing ..	61
4.4.8 Setup menu - recipe setting.	26	10 ROUTINE MAINTENANCE	62
4.5 TFT DISPLAY variations	31	10.1 EXTERNAL CLEANING.....	64
4.5.1 "All in One" hot water dispensing.....	31	10.1.1 TFT cleaning.....	64
4.5.2 Cup station	32	10.1.2 Cleaning of chrome-plated surfaces	64
4.5.3 "YES" option	34	10.1.3 Cleaning of machine surfaces	64
4.5.4 "YES+?" option	37	10.1.4 Cleaning of solid/liquid grounds container.....	65
4.5.5 Cup height/presence sensor	39	10.1.5 Cleaning of instant products/ coffee bean containers	65
4.5.6 Energy save.....	41	10.2 CLEANING OF FUNCTIONAL UNITS.....	66
4.5.7 Light dose view.....	42	10.2.1 Cleaning mode access	66
4.5.8 Manual delivery stop.....	44	10.2.2 All in one Wash.....	68
4.5.9 RFID - Filter replacement CARIPURE100	45	10.2.3 Semi-automatic cleaning of the Espresso/ Fresh Brew units.	72
4.5.10 MDB payment system	46	10.2.4 LIGHT cleaning of the Espresso/ Fresh Brew units.....	74
		10.2.5 Manual cleaning of the Espresso unit.....	75
		10.2.6 Mixer automatic cleaning.....	78

10.2.7	Disassembly and manual cleaning of the instant products Mixer ...	78
10.2.8	Cleaning of Milker circuit	80
10.2.9	Disassembly and manual cleaning of Milker.....	82

11 TROUBLESHOOTING 85

11.1	DEFINITION OF ERRORS AND ALARM LEVELS	86
11.2	ESPRESSO GROUP ERRORS ..	86
11.3	FRESH BREW GROUP ERRORS	87
11.4	STEAM ERRORS	88
11.5	ERRORS WATER ENTRY	88
11.6	MISSING COFFEE ERRORS.....	88
11.8	MDB ERRORS	90
11.9	HIGH-LEVEL GENERAL ERRORS	90
11.10	MEDIUM-LOW LEVEL GENERAL ERRORS	91

12 DISPOSAL AND DECOMMISSIONING 93

1 GENERAL SAFETY WARNINGS

This manual is integral part of the machine it is supplied with.

Before proceeding with installation, use and maintenance of the machine, the operator is held to read and fully understand the contents of this manual.

The machine is intended for professional use. Always strictly follow the instructions contained in this manual and keep it in a safe, dry place for future reference.

The weighted, equivalent sound pressure level is below 70 dB.

After having unpacked the machine, verify its integrity. In case of damage or doubts about the packaging content, contact the Service Centre. Handle the machine with care to prevent the risk of impacts or falls that may cause damage.

Keep packaging parts (box, inner protections, etc..) out of reach of children since they are potentially dangerous. Do not dump those parts into the environment, but dispose them according to applicable regulations.

NOTE

01

This symbol on the product or on the packaging indicates that the product shall not be treated as household waste, as it shall be delivered to an authorised waste collection point for recycling of electric and electronic devices.

02

For more detailed information about recycling of this product, contact the local authority, the local waste disposal service.

Do not position the machine in close proximity of water jets or heat sources. Avoid the direct contact with water or other liquids also during cleaning.

Do not expose the machine to weather conditions (sun, rain, etc.).

Before plugging the machine in, make sure the power switch is on "0" position.

For electric safety of the machine, it is necessary to provide a grounding system complete with a residual current circuit breaker (max IDN = 30mA).

Before connecting the device, make sure the data on the plate correspond to the power mains.

The Manufacturer declines any liability for failure to comply with the above or for damages caused by the failure to properly ground.

Unroll the power cord for its entire length to prevent the risk of dangerous overheating.

The electric system must be equipped with an omnipolar switch, in compliance with the applicable safety regulations, with contact opening gap and allowing the complete disconnection in the conditions of the overvoltage category III.

Unplug the machine for any intervention of routine maintenance or checking.

WARNING



Do not pull the power cord to unplug the machine from the electric socket.

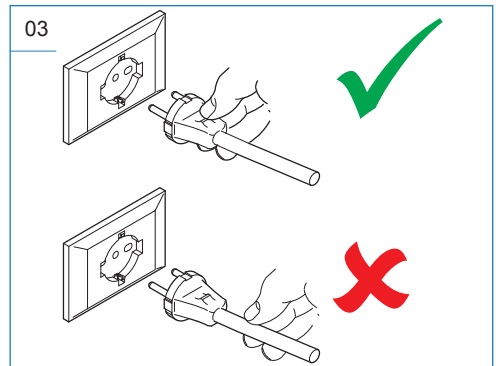

The machine can be used by children aged from 8 years and above and persons with reduced physical, sensory or mental capabilities or lack of experience and knowledge if they have been given supervision or instruction concerning use of the appliance in a safe way and understand the hazards involved. Children shall not play with the machine.

Remove the water tank from the machine when it is to be filled or for any other checking operation.

Never touch the hot parts of the machine.

Never touch the machine when hands or other body parts are wet.

Never immerse the machine in water.

The machine delivers high-temperature drinks. Avoid the risk of burns.

The machine is intended only for the purpose set forth in this manual. Any other use is considered as improper. The Manufacturer declines any liability for damage to things and/or persons arising from an improper use of the machine.

In case of fault or malfunctioning of the machine, switch it off and unplug.

In case of power cord damage, have it replaced by the Manufacturer, his authorized technical Service Centre or skilled personnel to prevent any risk.

For repairing, contact only a Service Centre authorised by the Manufacturer and require the use of original spare parts and accessories. Failure to comply with the above regulations could jeopardise machine safety.

For any communication regarding failures or malfunctioning, contact the nearest Service Centre, indicating the model, the type and the serial number of the machine. The data are shown on the apposite data plate.

In case the machine is not used any longer, render it inoperative.

NOTE



When required and in case of operations not described in this manual, contact the nearest Service Centre or the Manufacturer.

The Manufacturer reserves the right to carry out technical and aesthetic modifications to the machine and/or this manual for manufacturing or sales reasons without obligation to update the previous versions.

Owing to the above, some pictures contained in this manual may slightly differ from the actual product.

2 IDENTIFICATION

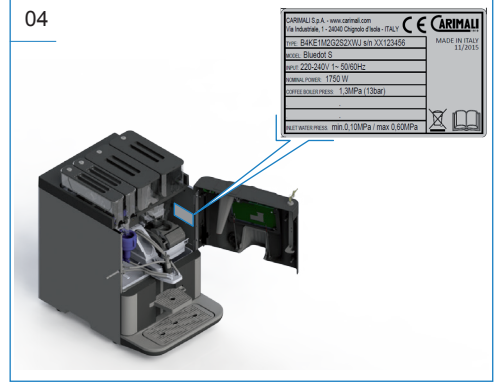

NOTE







The latest version of the manual can be accessed by entering the area reserved to customers of the official Carimali website.





3 INTRODUCTION

3.2 USER TYPES

This manual is a basic component for the use of the machine. It contains instructions and information about handling and usage of the machine in safety.

3.1 SYMBOLS

DANGER	
	It indicates a serious danger for the operator that may cause severe injury or death.
ATTENTION	
	It indicates a potentially dangerous situation for the operator that may cause severe injury.
WARNING	
	It indicates a potentially dangerous situation that may cause minor injury or machine damage.
NOTE	
	It points out notes or operation procedures that helps the operator when using the machine.

ICON	DESCRIPTION
	USER User in charge only of the simple use of the machine.
	FILLING AND MAINTENANCE OPERATOR User in charge of the filling/emptying of products and consumables, as well as routine maintenance.
	QUALIFIED TECHNICIAN Skilled operator in charge of installation, adjustment, advanced use, and routine maintenance.
	CARIMALI TECHNICIAN Skilled operator authorized by the Manufacturer, in charge of complex operations.

ATTENTION



Only the **CARIMALI TECHNICIAN** or a **SKILLED TECHNICIAN** have a shut-off key, which allows the access to moving parts or hot parts.



Be very careful during the maintenance or repairing procedures.

3.3 INTENDED USE

The “BLUEDOT” machine was designed and manufactured for dispensing hot drinks, such as:

- Coffee
- Instant products
- Tea
- Milk.

The machine is intended for professional use, such as:

- Refreshment areas in shops
- Refreshment areas in offices
- Refreshment areas in other environments
- Holiday farms
- Hotels
- Motels
- Bed & Breakfast.

ATTENTION



The machine is not intended for outdoor use.

3.3.1 Reasonably foreseeable misuse

WARNING



In order to ensure safety of the operator and the machine, it is strictly forbidden to use the machine in a different manner from that indicated in this manual.

4 DESCRIPTION OF THE MACHINE

4.1 MACHINE CONFIGURATIONS

	Brewer	Fresh Milk	G	S	X	Water supply
ESPRESSO BREWER						
BlueDot	E	0M	1G	0S	0X	WT - WM - WJ
BlueDot	E	0M	1G	2S	2X	WT - WM - WJ
BlueDot	E	0M	2G	2S	2X	WT - WM - WJ
BlueDot	E	1M	2G	0S	0X	WT - WM - WJ
BlueDot	E	1M	1G	2S	2X	WT - WM - WJ
BlueDot	E	1M	2G	2S	2X	WT - WM - WJ
BlueDot	E	1M	1G	3S	2X	WT - WM - WJ
BlueDot	E	0M	1G	3S	2X	WT - WM - WJ
FRESH BREWER						
BlueDot	F	0M	2G	0S	0X	WT - WM - WJ
BlueDot	F	0M	1G	2S	2X	WT - WM - WJ
BlueDot	F	0M	2G	2S	2X	WT - WM - WJ
BlueDot	F	1M	2G	0S	0X	WT - WM - WJ
BlueDot	F	1M	2G	2S	2X	WT - WM - WJ
ESPRESSO + FRESH BREWER						
BlueDot	EF	0M	2G	0S	0X	WM
BlueDot	EF	1M	2G	0S	0X	WM
BlueDot	EF	0M	3G	0S	0X	WM
BlueDot	EF	1M	3G	0S	0X	WM
ESPRESSO + TEA BREWER						
BlueDot	ET	0M	2G	2S	0X	WM
BlueDot	ET	1M	2G	2S	0X	WM

Key:

E Espresso brewer

F Fresh Brewer

EF: Espresso brewer + Fresh Brewer

ET: Espresso brewer + Tea Brewer

M MILK

S: Instant products / Tea containers

G: Coffee grinder

X: Mixer

WT: Water tank

WM: Water connection

WJ: Jolly water supply

Optional:

- Water supply connections
- Jolly water supply (tank + water connection)
- 100 l CariPure water filter
- Premium grinder set
- Premium Self (Cup station)
- Sensor of presence and cup size
- MaxSave energy savings
- Aroma fan
- Liquid grounds direct discharge
- Solid grounds direct discharge
- GSM modem
- RFiD
- Wi-Fi
- Cash and cashless payment system
- Grounds drawer with compactor
- Raised product containers

Additional units:

- Fridge with digital temperature
- Hot and Cold

4.2 OUTER COMPONENTS

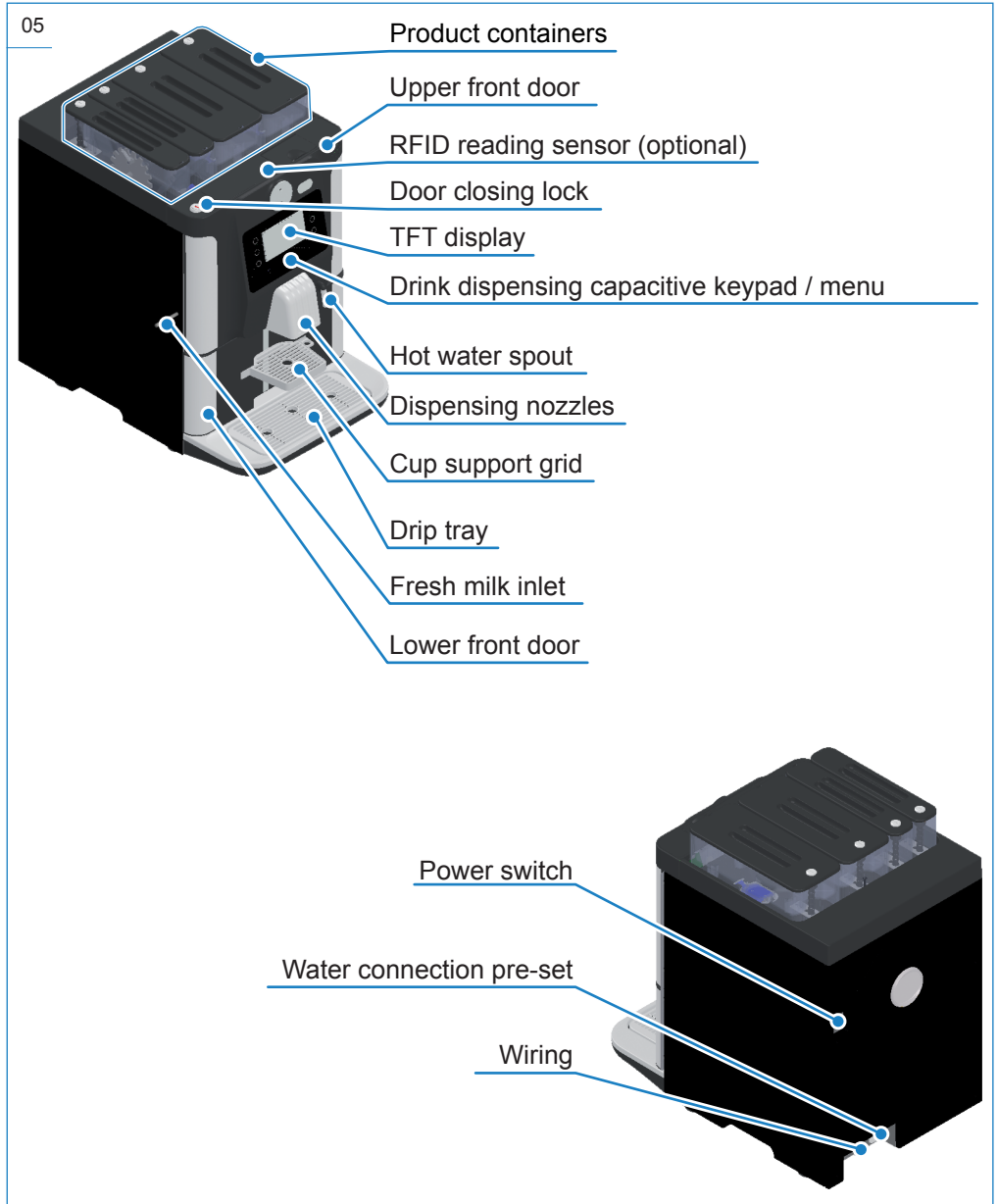

4.3 INNER COMPONENTS

NOTE



The machine can be set up (modular) according to customer's requirements. The main components are listed below.

NOTE



All configurations described here below can have more or fewer optional extras installed (raised containers, grounds drawer with compactor, aroma fan, etc..) according to customer requirements.

06 Version Espresso "E" + instant products (Tank or water connection or Jolly)

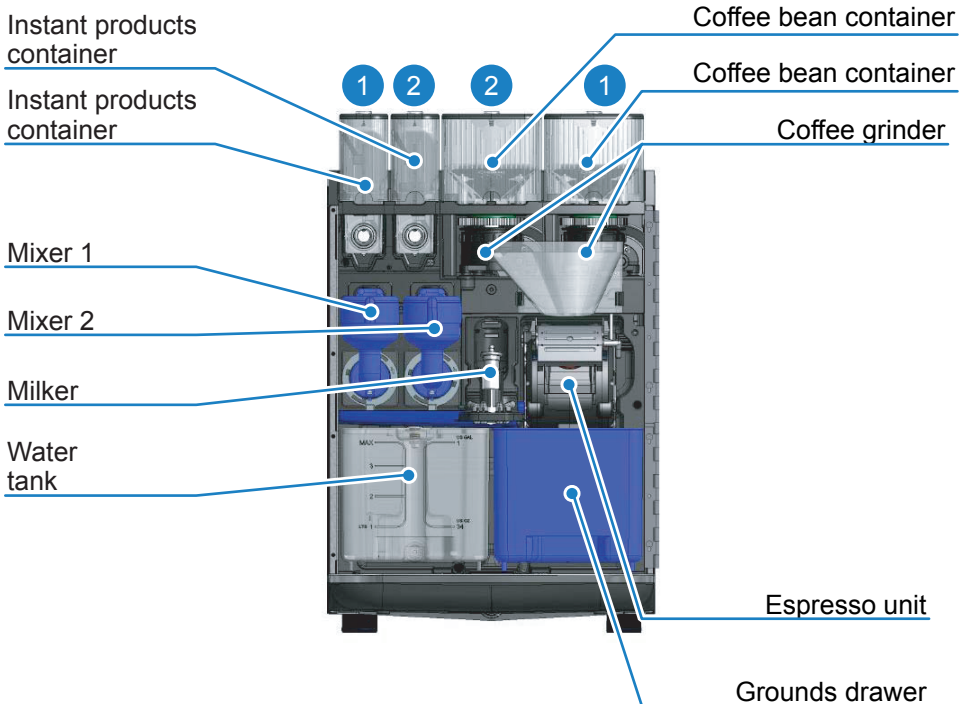

07 Version Fresh Brew "F" + instant products (tank or water connection or Jolly)

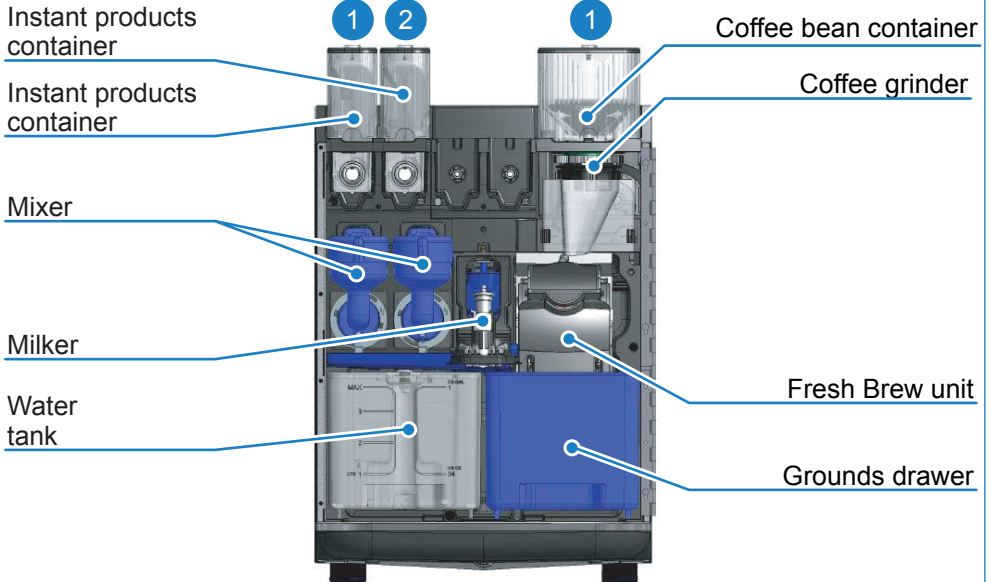

08 Version Espresso + Fresh Brew "EF" (with water mains only)

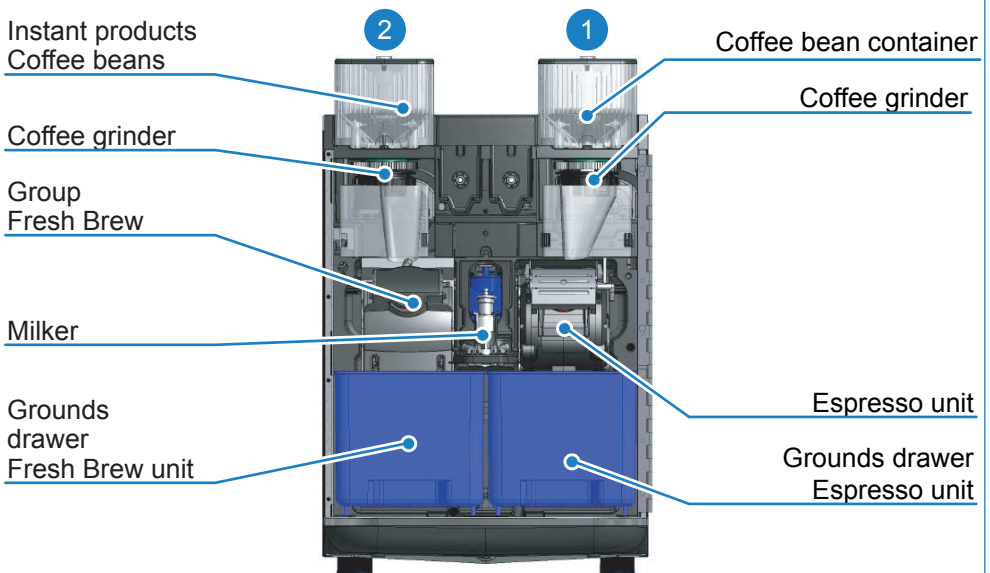

09 Version Espresso "E" + instant products (Tank or water connection or Jolly)

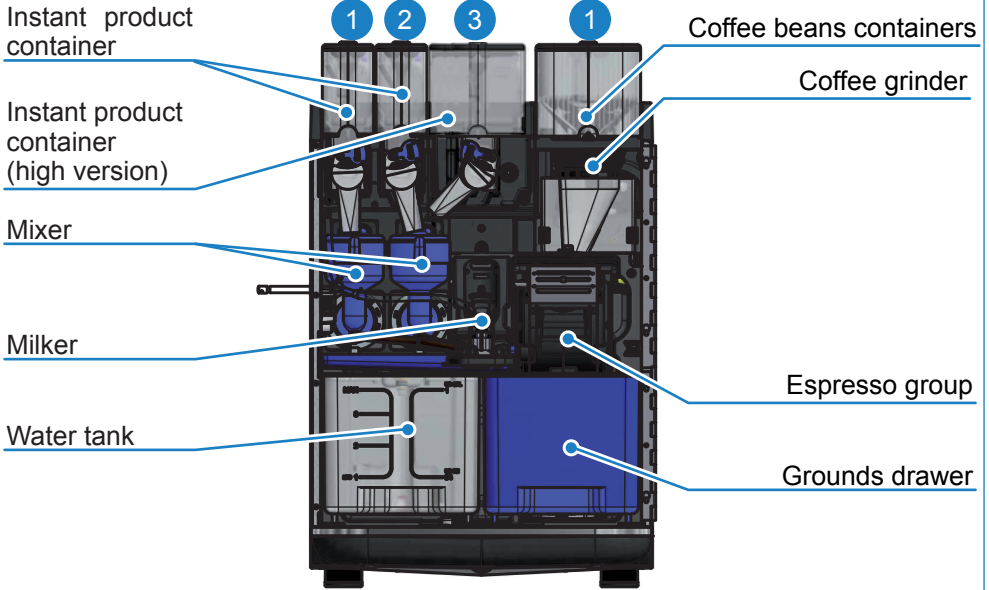

10 Version Espresso "E" + instant products (Tank or water connection or Jolly)

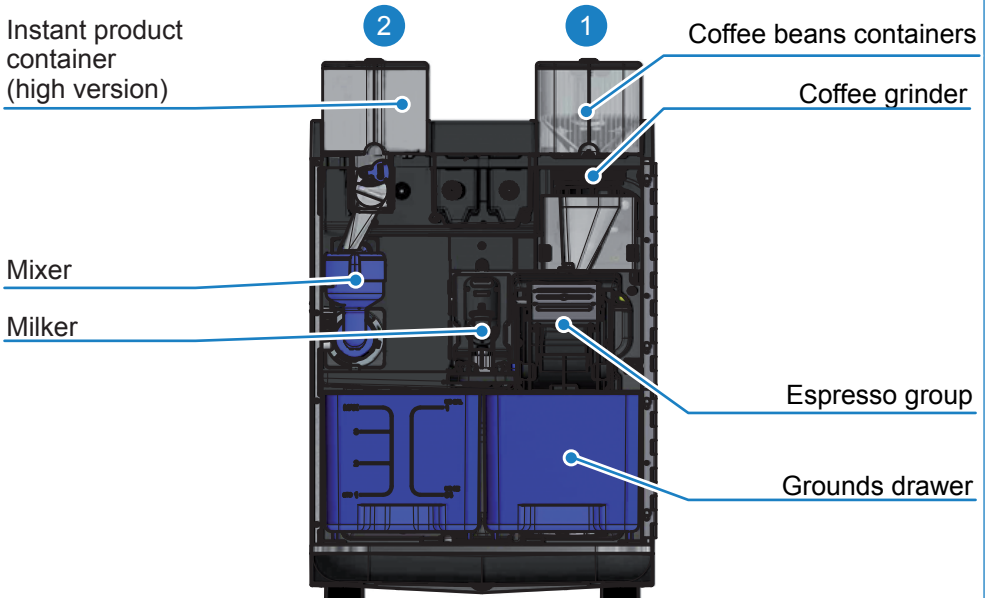

11 Version Espresso + Fresh Brew "EF" (with water mains only)

Coffee bean container

Coffee grinder

Group Fresh Brew

Milker

Grounds drawer Fresh Brew unit

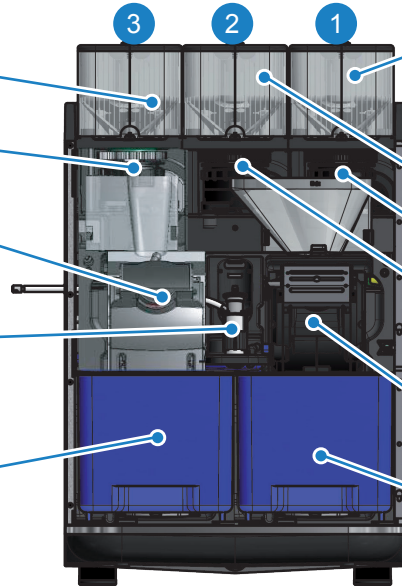

Coffee bean container

Coffee bean container

Coffee grinder

Coffee grinder

Espresso unit

Grounds drawer Espresso unit

12 Version Espresso + Tea "ET" (water mains only)

Instant products container

Instant products container

Group Fresh Brew

Milker

Grounds drawer Fresh Brew unit

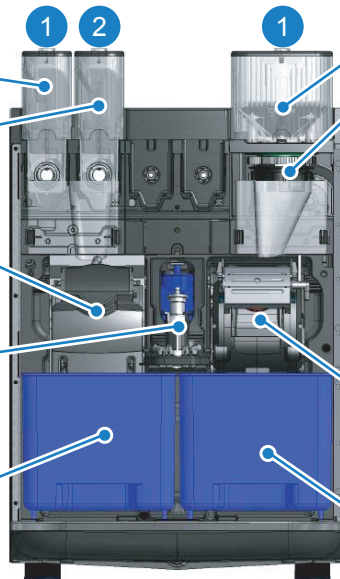

Coffee bean container

Coffee grinder

Espresso unit

Grounds drawer Espresso unit

13 Version Espresso (tank or water connection or Jolly)

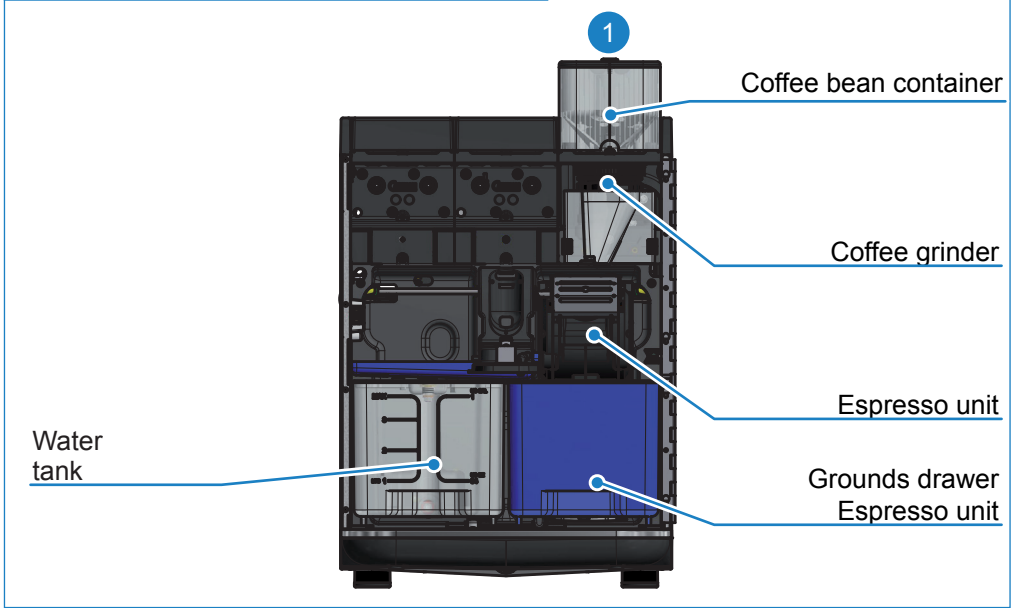

14 Version Espresso (tank or water connection or Jolly)

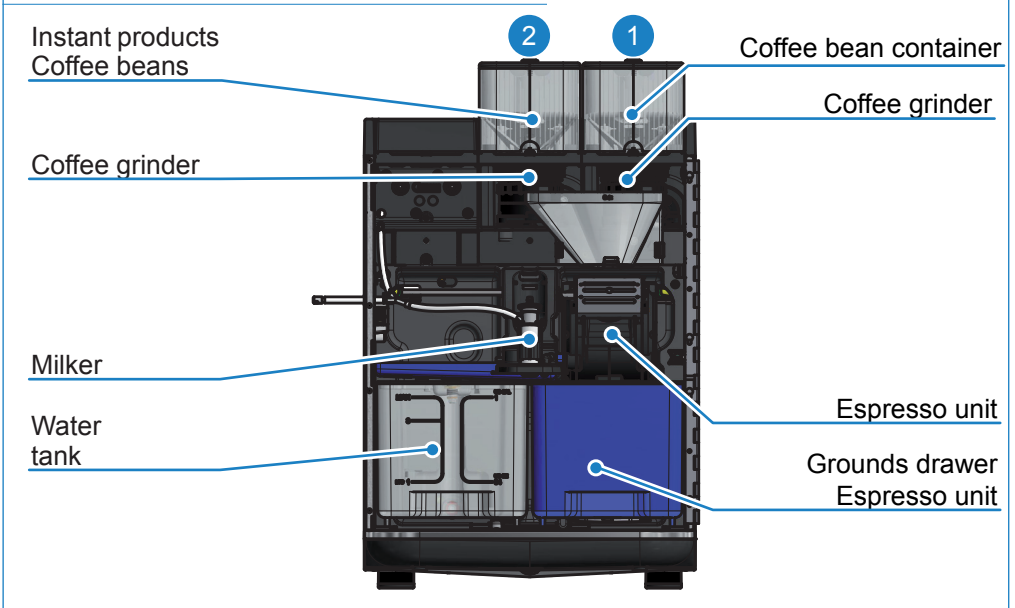

15 Version Espresso "E" + instant products (Tank or water connection or Jolly)

Instant products container

Instant products container

Instant products container

Mixer 1

Mixer 2

Milker

Water tank

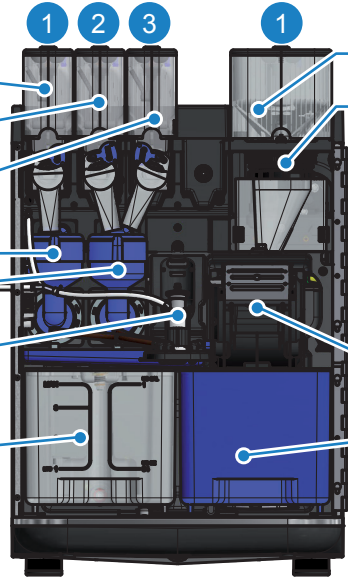

Coffee bean container

Coffee grinder

Espresso unit

Grounds drawer
Espresso unit

4.3.1 Product containers

16 - Instant product container

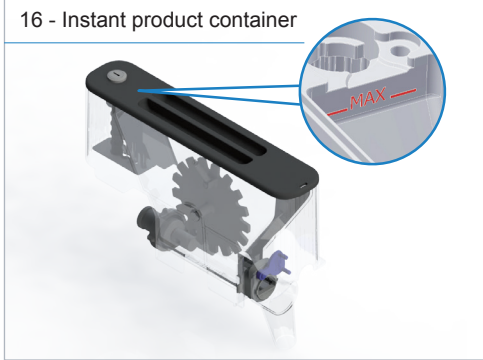

Standard container capacity
1.1 litres

Raised container capacity
1.8 litres

WARNING



When the container is filled with the product, close the lock protection; open it after filling.

Standard container capacity
0.6 Kg / 1.8 l
Raised container capacity
1.2 Kg / 3.5 litres

WARNING



When the container is filled with the product, close the lock protection; open it after filling.

NOTE



Never fill the containers above the max. level indicated.

4.3.2 Reduced inlet for containers

Substitute the standard inlet with the reduced inlet supplied as standard (Cod. 37.05443) when:

- The machine with soluble containers in which topping will be utilized instead of the soluble powder;
- The machine in tea configuration in which a blend of tea will be utilized with leaves chopped to reduced dimensions.

17 - Coffee bean container

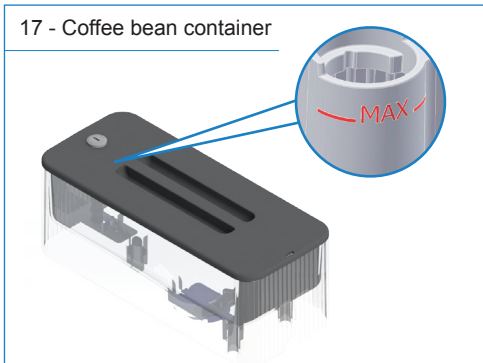

18 - Reduced inlet for containers



4.4 TFT DISPLAY

4.4.1 Power ON - Switching on

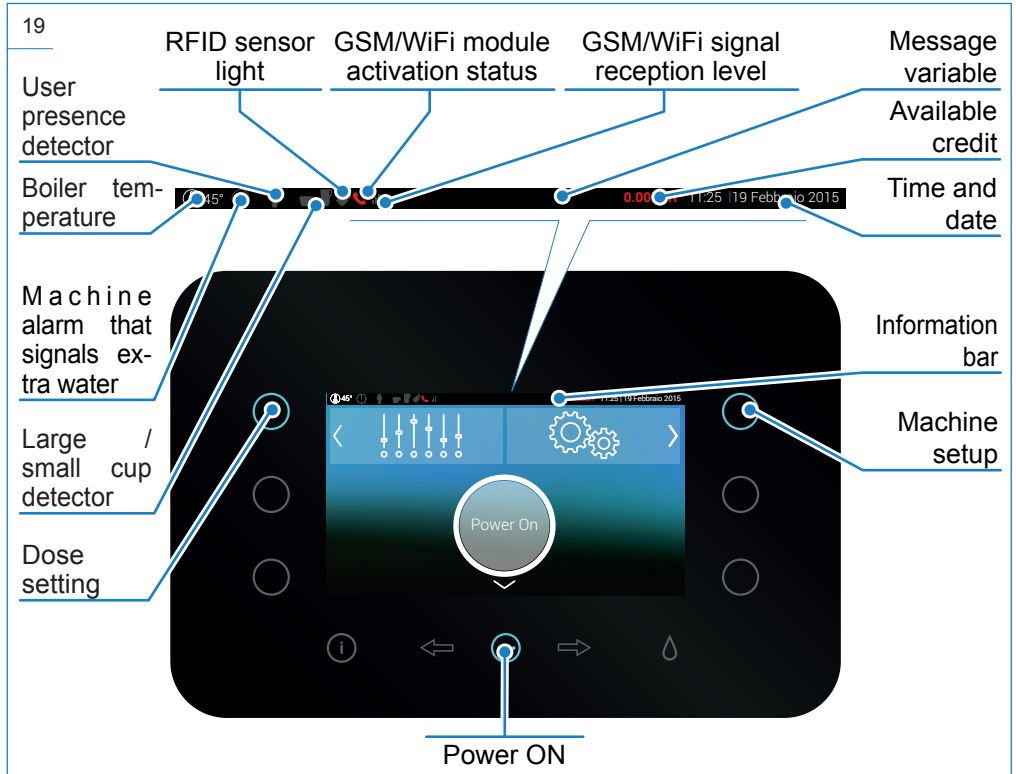

NOTE



If the boiler or the exchanger (if fitted) does not reach the working temperature, when pressing "Power ON" the corresponding heating screen is shown.

NOTE



The info bar icons described refer to the machine with all optional extras. If your machine does not have all of the optional extras, some of the icons will not be shown on the display.

4.4.2 Heating waiting screen (Boiler-exchanger)

20

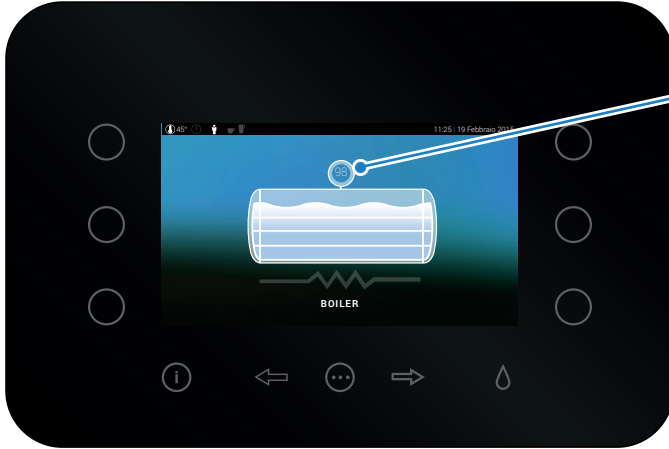

Temperature gauge

NOTE



The screen is visualized when switching the machine on or anytime the temperature of the boiler or the exchanger goes below the minimum drink dispensing temperature.

NOTE



The heating of the exchanger begins after the one of the boiler.

4.4.3 Introduction

21



Introductory video

4.4.4 Selection of beverages to be dispensed (example of beverages) (free vend)

22

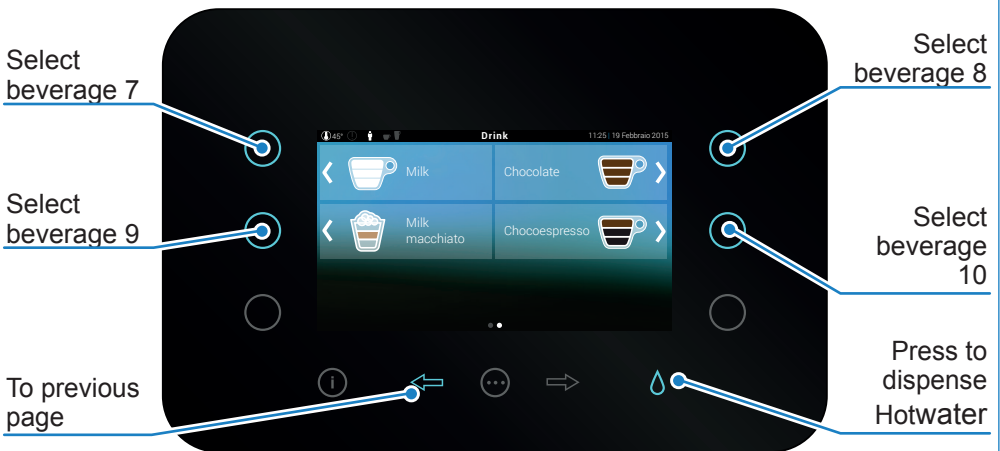

It is possible to set up to 4 product pages.

4.4.5 Hot water delivery

23

Small water amount dispensing

Medium water amount delivery

Free water amount delivery (start/stop)

Return to beverages page



4.4.6 Dispensing in process

24

Selected beverage memo

Delivery progress bar

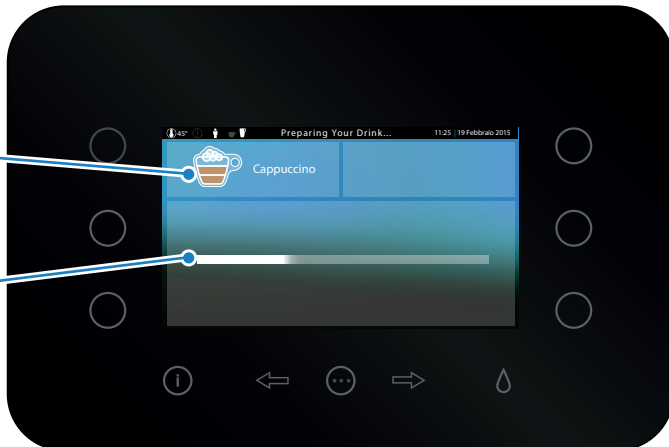

4.4.7 Delivery completed

25

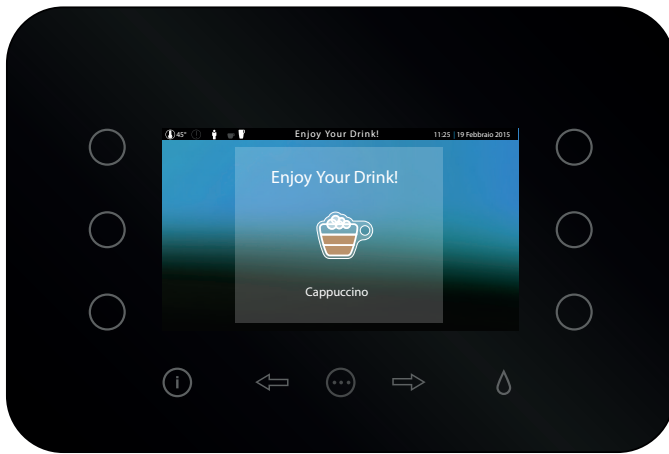

At the end of dispensing, an acoustic alarm signals that the machine completed its cycle and is ready for a new dispensing.

4.4.8 Setup menu - recipe setting

NOTA



Minimum access level.



From the “Power ON” screen, press the “Dose setting” key to enter the product screen with yellow labels showing the possibility of modify the recipes.

26 - Beverage setting screen (beverages example)

Press to set Espresso

Press to set Long coffee

Press to set Cappuccino

To next screen

Press to set Long Espresso

Press to set Caffè Creme

Press to set Medium filter coffee

This symbol signals that the drink dispensing is disabled.

27 - Selection screen of settings to modify

Press to exit on power ON screen

Press to access the menu selected

Press to scroll the list

Press to return to the previous screen

28 - General setting page

Press to exit on power ON screen

Button “-” Scrolling of icons/name/ number of products

Press to confirm

Press to scroll the list

Press to return to the previous screen

Button “+” Scrolling of icons/name/ number of products

According to setting of the parameter “product number”, the menus “product composition” and “product settings” will vary.

29 - Product composition page

Press to exit on power ON screen

Key “-” scrolling to previous product option

Press to confirm

Press to scroll the list

Press to return to the previous screen

Key “+” scrolling to the next product option

The composition of the available drinks, according to the machine configuration, are listed below:

- Espresso
- Fresh brew
- Instant product
- Milk
- Hot water

Each drink composition defines the type and the parameters to set in the menu “Product setting”.

30 - Product setting page

The screenshot shows a mobile application interface titled "Drink settings". At the top, it displays "Espresso" and "Drink composition". Below this is a list of three parameters: "Parameter #1", "Parameter #2", and "Parameter #3", each with a value of "XXXXX". The list is flanked by up and down arrow icons. At the bottom, there are navigation icons: a back arrow, a checkmark, a forward arrow, and a water drop icon. A callout box highlights the list of parameters.

Selected product

Press to exit on power ON screen

Press to access the modification.

Settable parameters

Press to scroll the list

Press to return to the previous screen

NOTE



This page allows to modify the composition of the drink by modifying the parameters.

31 - Parameter changing page

The screenshot shows a mobile application interface titled "Drink composition reference". It features a numeric input field with the value "0" highlighted in yellow. To the right of the input field are plus and minus arrow icons. Below the input field are navigation icons: a back arrow, a checkmark, a forward arrow, and a water drop icon. A callout box highlights the numeric input field.

Scrolling of the value to set

Press to confirm the value

Press to increase/reduce the value

Press to return to the previous screen

Scrolling of the value to set

SETTABLE PARAMETERS:

Comp. beverage	Element	Min. value	Max. value	Unit of measure	Other /Notes
ESPRESSO	Origin				Grinder 1 Grinder 2 Grinder 3 Decaf Grinder 1 and 2
	Delayed start time	0	300	Tenths of a second	
	Grinding time	0	150	Tenths of a second	
	Water dose pulses	0	500	No.	
	Empty coffee chamber	249	251	No.	
	Water adding pulses	0	400	No.	
	Pre-infusion time setting	0	50	Tenths of a second	
	Pre-infusion pause setting	0	150	Tenths of a second	
FRESH BREW	Coffee expansion chamber	0	30	No.	
	Origin				Grinder 1 Grinder 2 Grinder 3 Instant product motor 1 Instant product motor 2 Grinder 1 and 2
	Delayed start time	0	300	Tenths of a second	
	Grinding time	0	150	Tenths of a second	
	Water time 1	0	200	Tenths of a second	
	Infusion pause setting	0	150	Tenths of a second	
	Air pump time	0	150	Tenths of a second	
	Air pump motor PWM1	1700	1800	No.	Recommended value 1800
Water time 2	0	200	Tenths of a second		
Water time 3	0	10	Tenths of a second		

Comp. beverage	Element	Min. value	Max. value	Unit of measure	Other /Notes
INSTANT PRODUCT	Origin				Instant product motor 1 Instant product motor 2 Instant product motor 3
	Delayed start time	0	300	Tenths of a second	
	Water dispensing delayed start	0	350	Tenths of a second	
	Mixer motor time ON	0	370	Tenths of a second	
	Mixer motor delayed start	0	350	Tenths of a second	
	Instant product motor time ON	0	350	Tenths of a second	
	Instant product motor delayed start	5	350	Tenths of a second	
	Mixer speed setting	0	2	No.	0 maximum speed 1 medium speed 2 min. speed
Instant product delivery steps	0	2	No.	0 delivery without interruption 1 one pause during delivery 2 two pauses during delivery	
MILK	Delayed start time	0	300	Tenths of a second	
	Steam dispensing time	0	200	Tenths of a second	
	Milk aerator delayed start	10	160	Tenths of a second	
	Milk aerator time	0	200	Tenths of a second	
	Steam delay	15	25	Tenths of a second	
	Pump forward time	0	300	Tenths of a second	
	Pump forward speed	20	60	Percentage	Value set in 1% increments on the basis of the maximum speed of the pump with limits from 20% to 60%.
HOT WATER	Delayed start time	0	300	Tenths of a second	
	Dispensing time	0	350	Tenths of a second	

4.5 TFT DISPLAY VARIATIONS

4.5.1 “All in One” hot water dispensing

Setting the “Hot water outlet” function to “All in One”, hot water dispensing is possible only when there are no doses (hot water dispensing on request).

To dispense hot water using the drinks selection screen, keep the key  pressed until the dose required is reached.

32

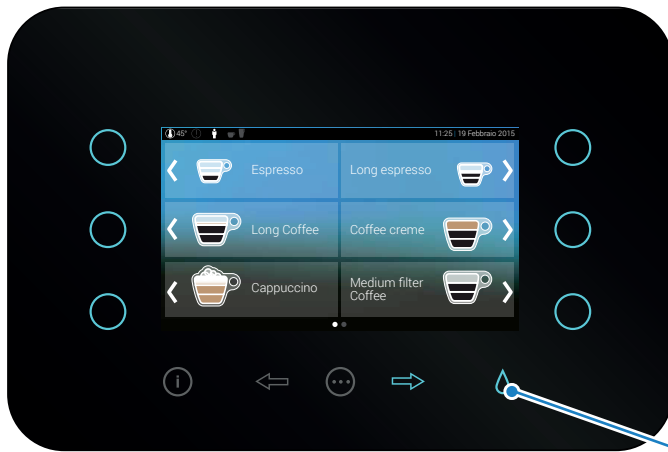

Press to dispense Hotwater

NOTE



The sub-menu of hot water selection will not be visualized.

4.5.2 Cup station

NOTE



If the “Cup Station” option is enabled, every time delivery of a drink is selected, the system checks the closing state of the front door.

NOTE



The version with “Cup Station” features one only front door. Open the door with the key for emptying the drawer of used grounds. After emptying, when closing the front door, confirm the drawer emptying on the display.

If the door is open, the display shows the following page of door closing request.

33

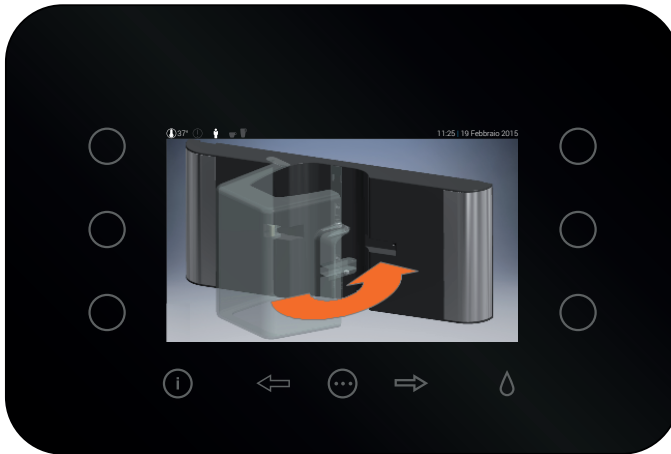

NOTA



If the “Door Locked” function is active, the front door cannot be split between top and bottom, but it is a single piece and to open it, the lock must be released.

Once having closed the front door, the dispensing starts automatically.

34

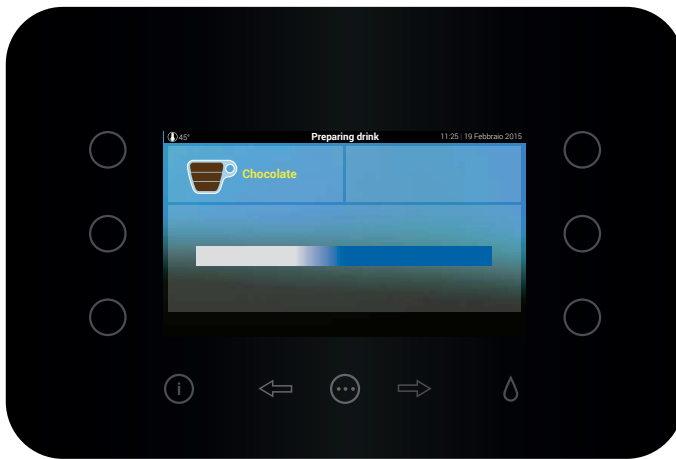

NOTA



During delivery, the door cannot be opened and will remain locked until the end of the process.

Subsequently, the end of delivery page is visualized.
The door can be opened and the beverage taken out.

35

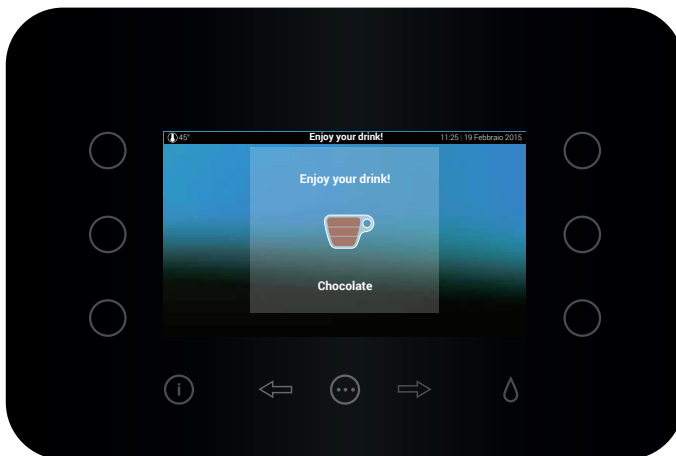

4.5.3 “YES” option

When the coffee grounds drawer is full, the machine will show:

36

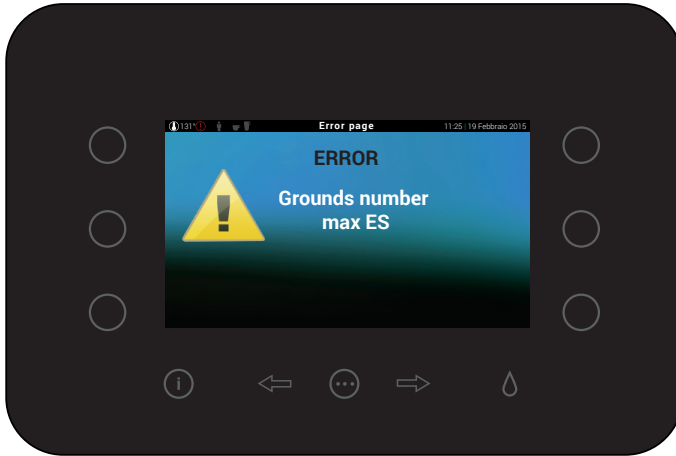

Open the front door, that result a single unit.

37

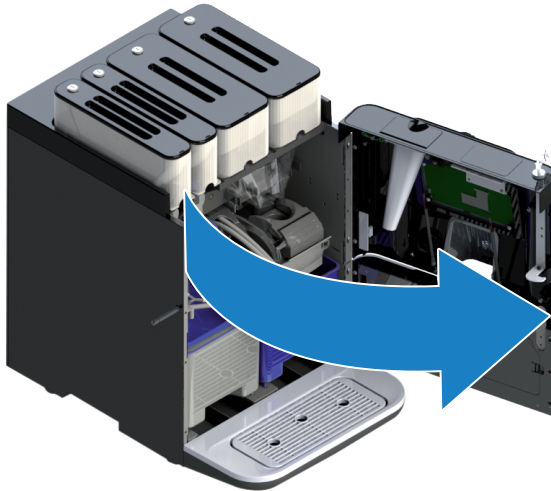

NOTE



The machine will switch off automatically and will restart when the front door is closed.

Remove the grounds drawer and empty out the coffee grounds.
Refit the grounds drawer and close the front door again.

38

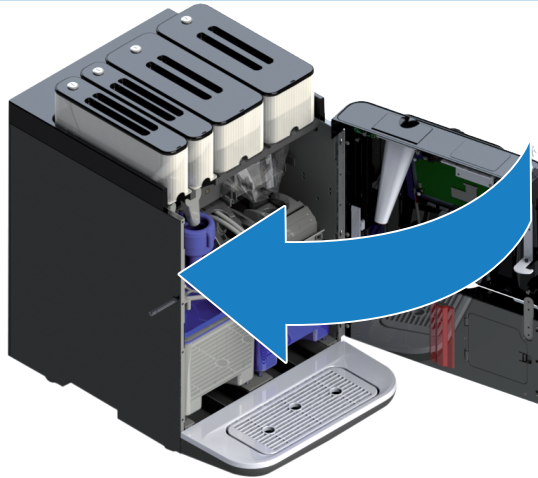

The machine will restart, showing the “Power ON” screen.

39

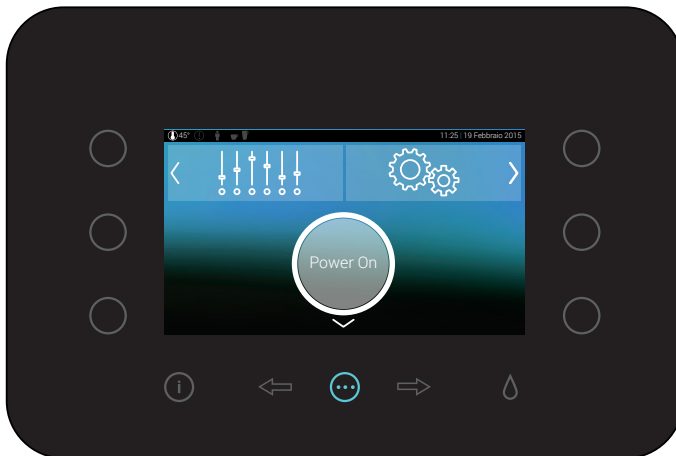

Press  to switch on the machine. The display will read:

40

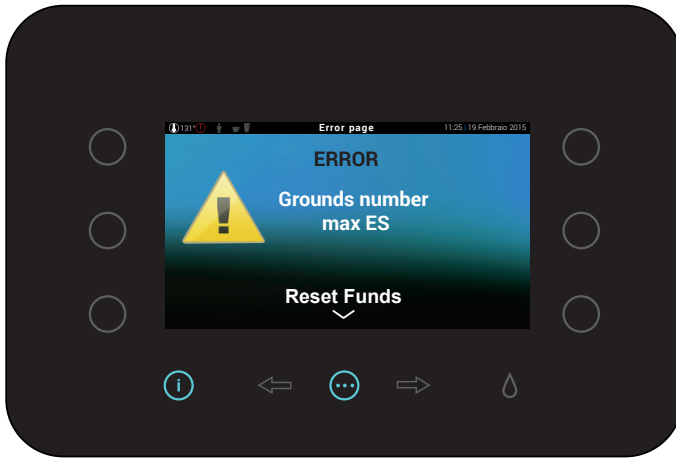

Press  to confirm emptying of the coffee grounds drawer and reset the grounds counter.

4.5.4 “YES+?” option

Regardless of the coffee grounds drawer being full, when “Power ON” is pressed, the machine will ask if the drawers have been emptied.

41

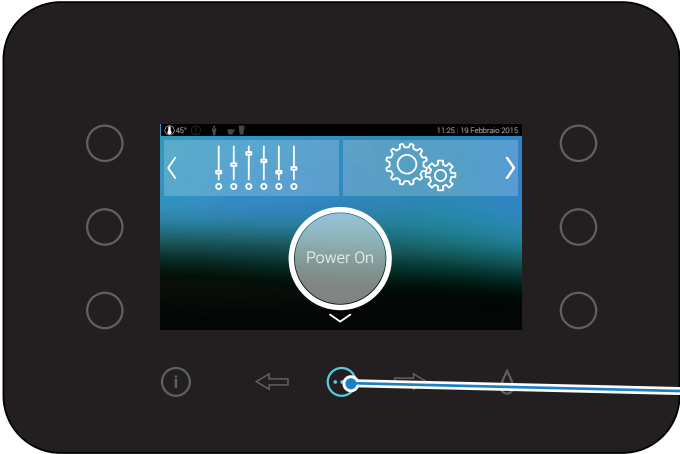

Press to switch on the machine.

42

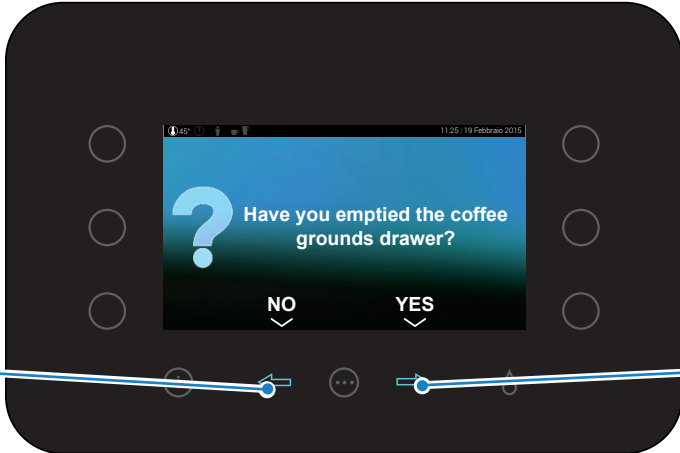

Press to start the machine without resetting the grounds counter.

Press to confirm emptying of the coffee grounds drawer. The coffee grounds counter will be reset

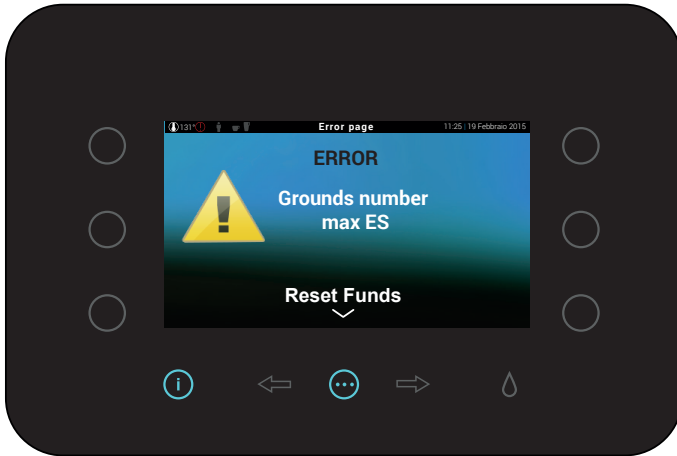

Press  to confirm emptying of the coffee grounds drawer and reset the grounds counter.

4.5.5 Cup height/presence sensor

NOTE



If the “Height / presence cup” option is enabled and the beverage recipe has been set for the types of cup suited to the delivery, each type the beverage delivery is selected, the system will check for the presence of a suitable cup on the cup sensor.

SENSOR	DISPLAY	OPERATION
Low		<p>It enables dispensing if a small cup is placed in correspondence of the low sensor.</p>
High		<p>It enables dispensing if a small cup is placed in correspondence of the high sensor or, when there is no cup protection door, if a small cup is positioned on the cup holder, in correspondence of the high sensor.</p>
Jolly		<p>It enables dispensing if a cup (big or small) is placed in correspondence of one of the two sensors (high or low).</p>

NOTE



When the user does not position the correct cup, the drink will not be dispensed.

Once having positioned the correct cup, the machine will proceed with the drink dispensing.

44

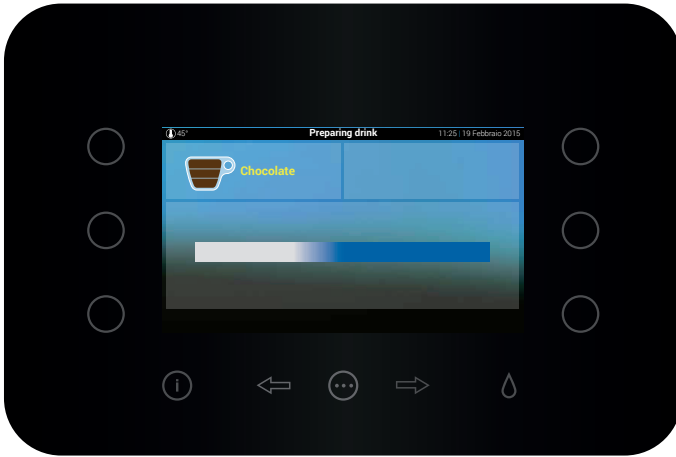

After dispensing, the following page is shown.

45

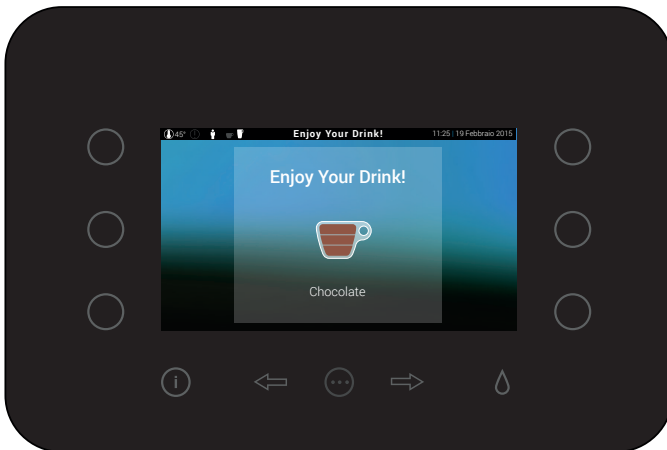

The beverage can be taken out.

4.5.6 Energy save

NOTE



Technical access level.



NOTE



When the energy saving option is enabled, it will be applied only with the machine on. The software will activate the energy saving mode according to five conditions:

- User's presence, if no user is detected.
- Cup presence, if no cup is detected.
- Timeout timer, based on a configured "time".
- No drink dispensing.
- No button pressure.

In all these conditions are present, the machine enters the "Energy Save" mode and a screensaver will appear on the display.

46

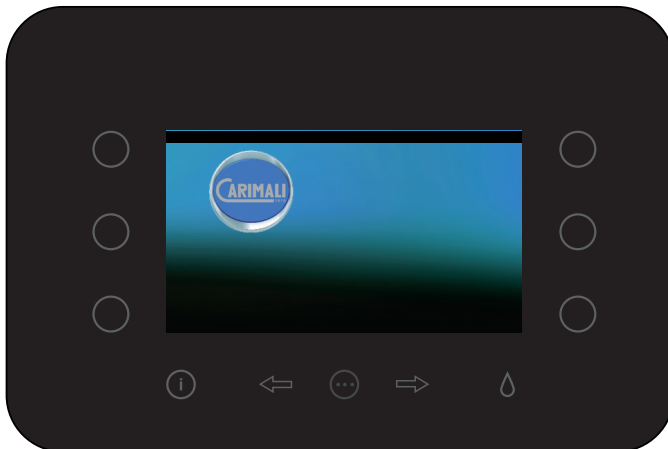

When one of the above condition is valid no longer, the system disable the "Energy Save" mode, resetting the working temperature according to the machine settings.

4.5.7 Light dose view

NOTE



Technical access level.



Press Machine Setup to access the maintenance management menu.

47

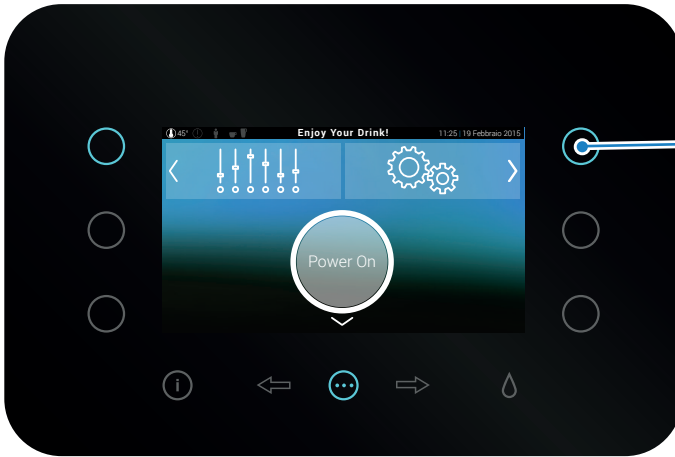

Machine
setup

Press "Doses counter" to access the dose counter menu.

48

Menu
Dose
counters



This menu allows to visualize:

- Total counter of the drinks dispensed
- Total counter of the drinks dispensed
- Total counter of the drinks dispensed in detail

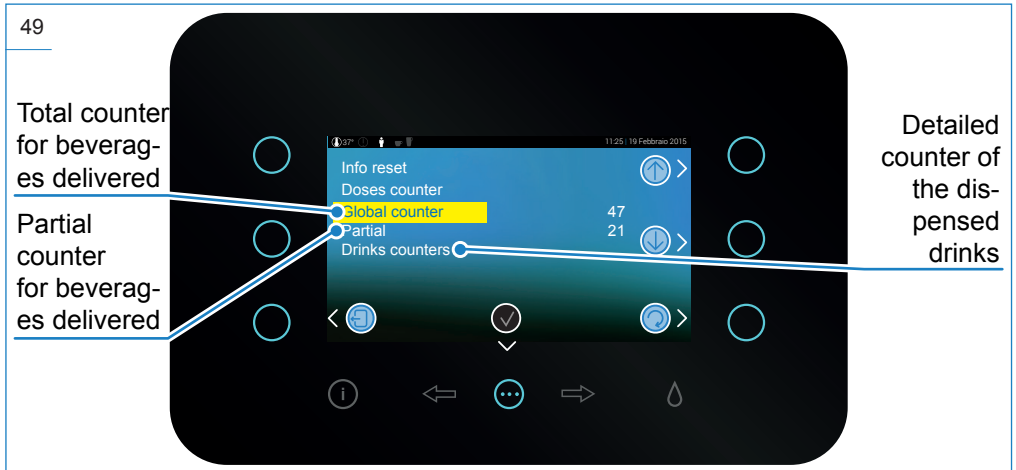

Accessing the detailed counter of the dispensed drinks, a screen can be view where the number of dispensing is shown next to each drink.

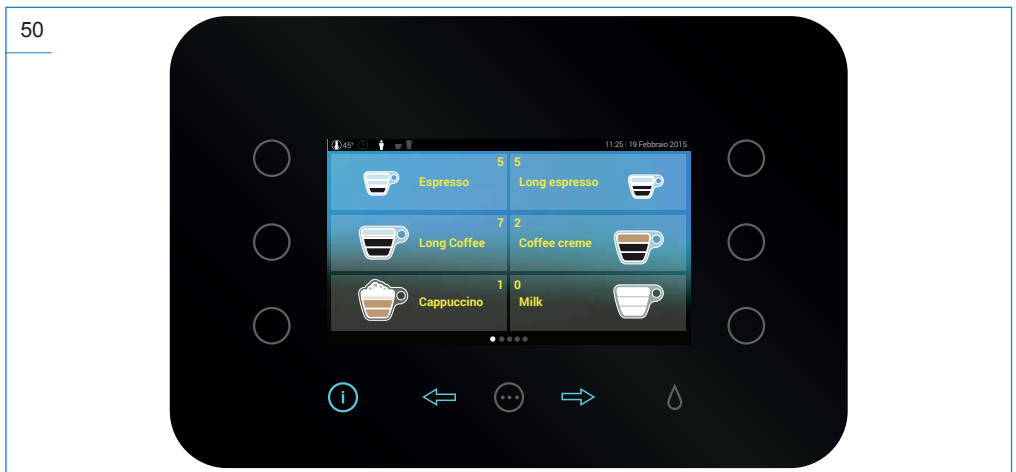

Press to exit the menu.

4.5.8 Manual delivery stop

NOTE



If the “Stop Dispensing” function is enabled, the user has the possibility to stop delivery manually.

Press “Stop Dispensing” to stop beverage delivery manually.

51

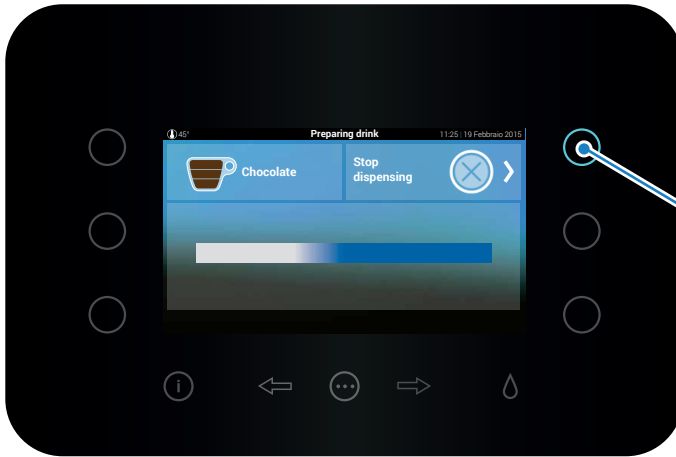

Manual
delivery
stop

NOTE



The manual delivery stop is not instant, but occurs when the system detects a safe situation for machine operation.

WARNING



If there is an MDB payment module, the necessary credit for delivery is subtracted in full, even if delivery is interrupted before completion.

4.5.9 RFID - Filter replacement CARIPURE100

NOTE



This function is only present if the RFID reading sensor (optional) is installed.

NOTE



If this function is present, the machine will automatically signal when it is time to replace the filter at the end of its useful life.

When purchasing the CARIPURE100 filter, move the filter package, where

the symbol is present, to the top part of the machine.

52



When the machine detects the filter (if compatible) it will show the following screen:

53

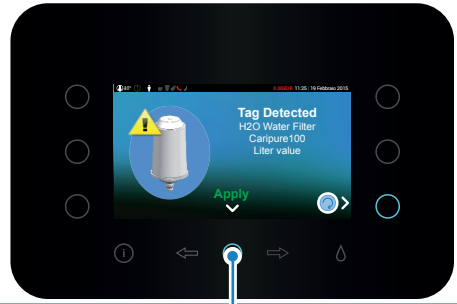

Confirms the filter identification

Confirming the request, it is possible to proceed to install the new filter. .

WARNING



On confirmation, the filter use counter will be reset.

WARNING



If the filter is not compatible, the display will show the following screen and it will not be possible to proceed with installation.

54

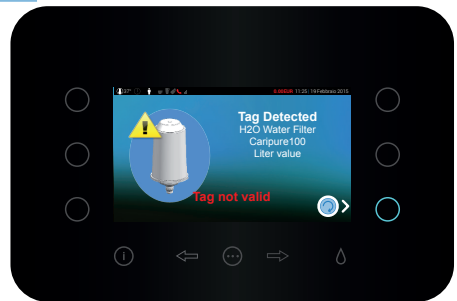

4.5.10 MDB payment system

NOTE



If the MDB payment system is installed and enabled, it is necessary to insert the required money to delivery the beverage.

WARNING



Beverage management can be managed from software (technical) and it is different according to the type of MDB installed.

NOTE



To set the price of each single beverage, it is necessary to access the selection option and then to select the price filed.

55

Press to exit the "Power ON" screen

Press to gain access to the modify price screen.

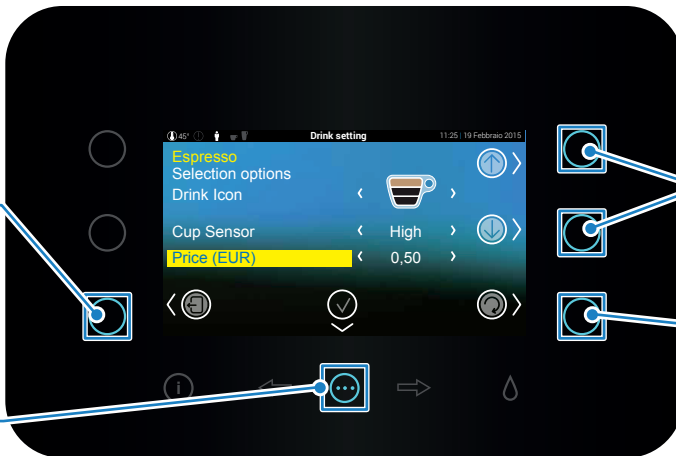

Press to scroll the list

Press to return to the previous screen

NOTE



The increase and decrease steps for price can vary according to the settings of the MDB module.

56

Press to confirm the set value

Press to select the price to set

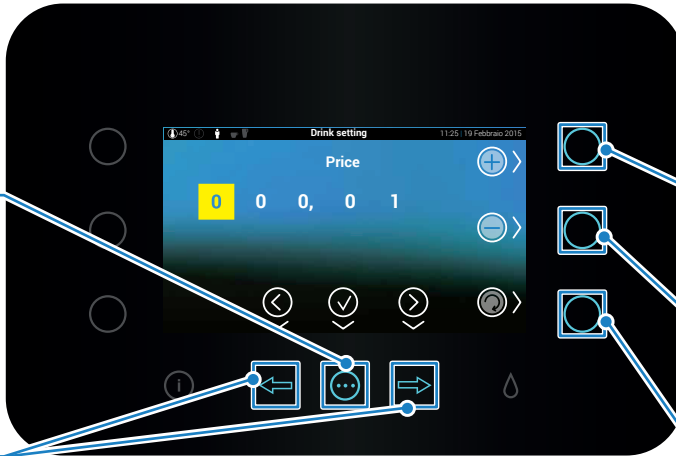

Press to increase the value of the price.

Press to decrease the value of the price.

Press to return to the previous page

NOTE



If the price is set at zero, the drink will be dispensed free of charge.

57

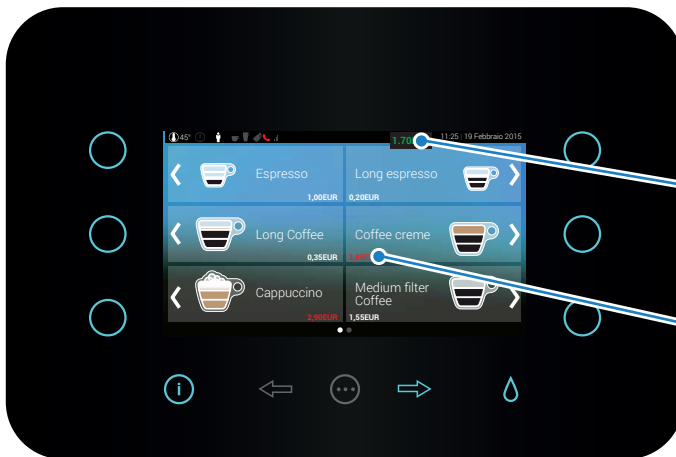

Available credit

Beverage price

NOTE



Based on available credit, the colour of the beverage prices will change:

- White: sufficient credit for delivery
- Red: insufficient credit for delivery.

NOTE



At the time of inserting the money into the MDB module, the value of the credit available on the display will become larger for a few seconds.

Press a beverage to be delivered in order to proceed.

58

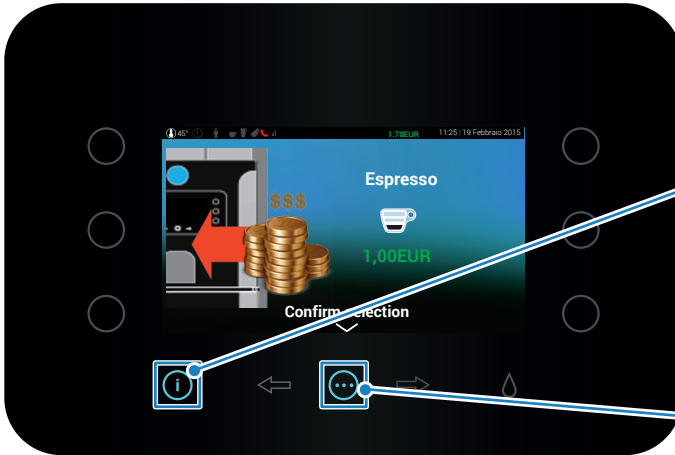

Press to return to the beverage selection.

Press to confirm the selection and proceed with delivery.

If the credit inserted is more than the price of the beverage, the machine will dispense change (if present and a compatible MDB module has been enabled).

59

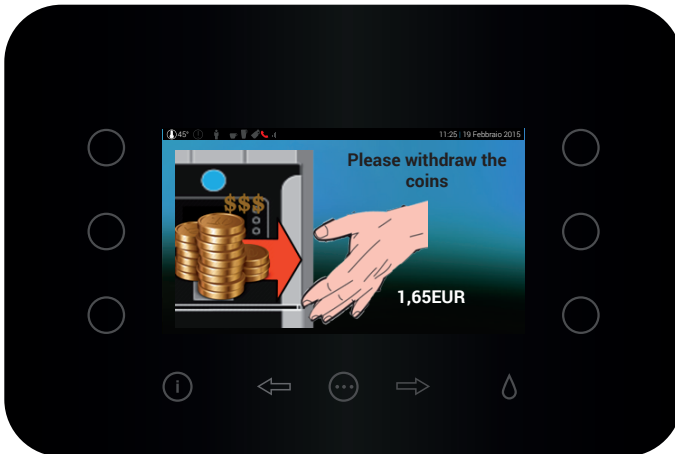

For further details on the MDB module, refer to the specific documentation.

5 TECHNICAL CHARACTERISTICS

5.1 TECHNICAL DATA

DESCRIPTION	DATA	UNIT OF MEASURE
Coffee boiler capacity	0.6	Litres
With grounds compactor	75	Pieces
Coffee bean container capacity	0,6 (1,8)	Kg (Litres)
Capacity of raised coffee bean container (optional)	1,2 (3,5)	Kg (Litres)
Water mains pressure (version with Water connection)	Max ~ 6 (0,6) Min ~ 1 (0,1)	bar (Mpa)
Instant product container capacity	1,1	Litres
Instant product raised container capacity (optional)	1,8	Litres
Drip tray capacity	1,0	Litres
Min./Max delivery height	80 - 170	mm
Tank capacity	4,0	Litres
Net/empty weight (without Milker)	25	Kg
Net weight (empty, with Milker)	27	Kg
Gross weight (machine loaded, without Milker)	30	Kg
Gross weight (machine loaded, with Milker)	32	Kg
Voltage	100-110 / 220-240v	V
Phase	1+N	
Frequency	50 - 60	Hz
Power	1700 (220-240V) 1400 (100-125V)	W

NOTE



According to Customer's requirements, it is possible to install the "Jolly" version of the machine, which allows to select the connection to water mains or the usage of water tank.

5.2 OVERALL DIMENSIONS

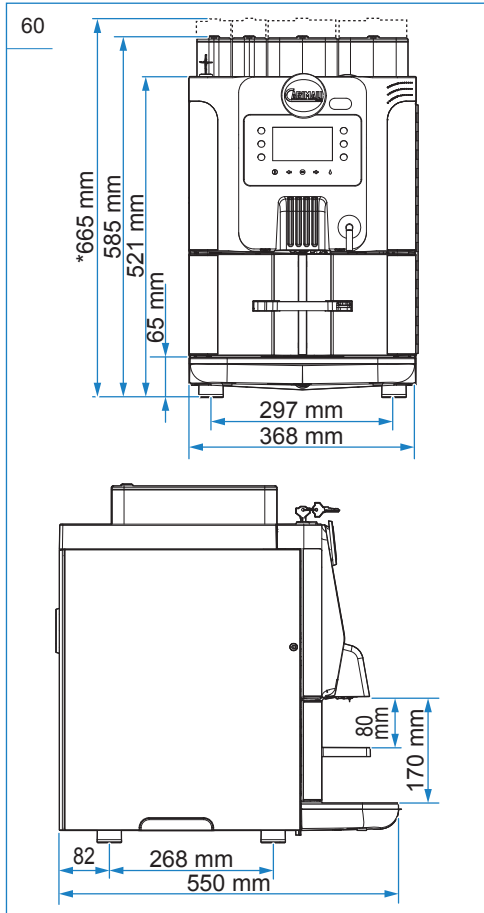

6 RESIDUAL RISKS

The Manufacturer pre-sets all necessary measures to ensure operator's safety when using the machine.

Anyway, some inconveniences may occur in certain conditions and/or situations.

The causes may be:

- Operator not suitably trained and/or experienced.
- Machine misuse.
- Use of foodstuffs close to their expiry date or already expired.
- Use of non-certified foodstuffs.
- Use of non-original spare parts.
- Unauthorized modifications on the machine.
- Improper maintenance of the machine.

NOTE



* = Overall machine dimensions with raised containers installed.

7 HANDLING AND STORAGE

WARNING

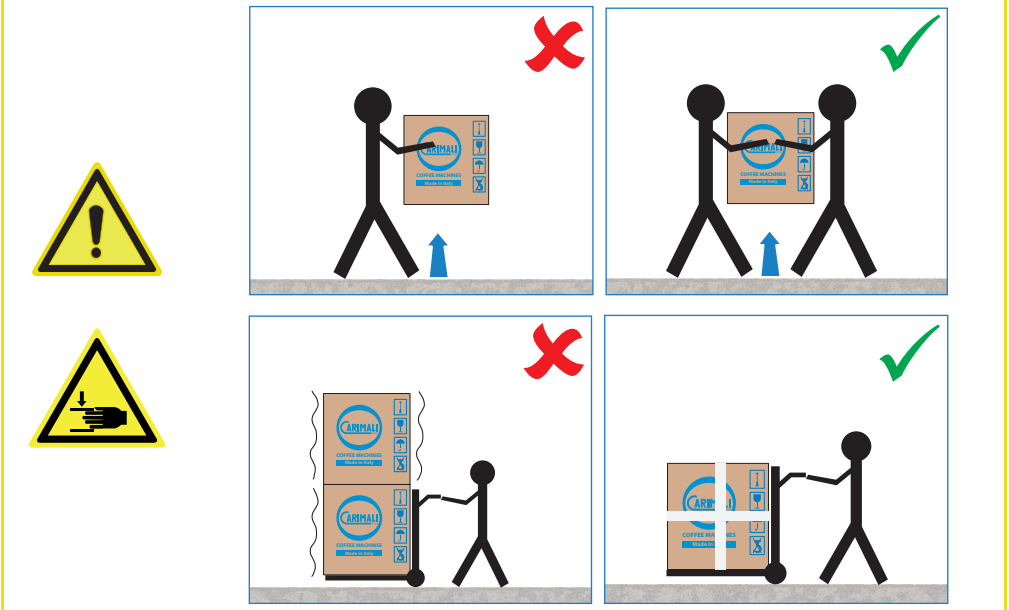

NOTE



Handle the packaging by means of the apposite carrying handles.

WARNING

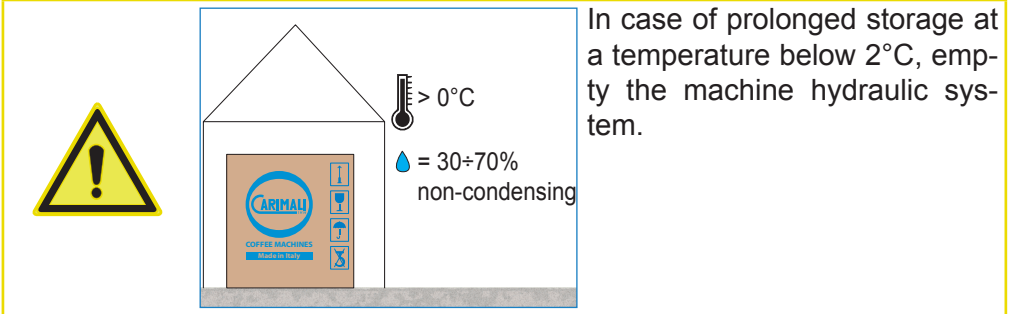

In case of prolonged storage at a temperature below 2°C, empty the machine hydraulic system.

8 INSTALLATION AND STARTUP

8.1 PACKAGING CONTENTS

61

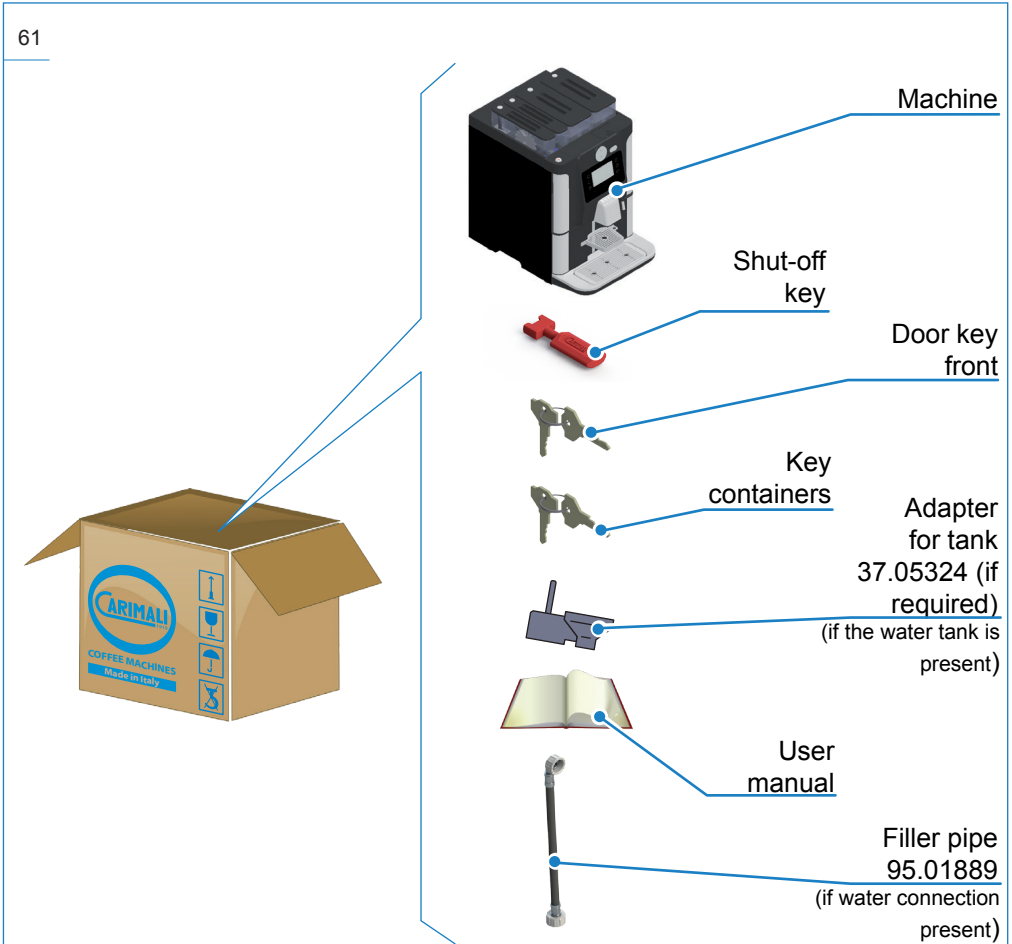

8.2 PRIOR CHECKING AFTER RECEIPT

Check the integrity of:

- External packaging;
- Internal packaging;
- Machine components (external and internal);
- Supplied accessories.

NOTE



In case damages or anomalies of the supply are noticed, contact the Manufacturer within 7 days from the purchase.

NOTE



The machine with raised containers cannot be installed on a surface under a wall unit, due to the increased dimensions.

8.3 POSITIONING

Position the machine:

- Indoor with temperature above 5 °C.
- At a minimum distance of 150 mm from walls or other objects, to facilitate ventilation.
- Horizontally, on a flat, stable surface, at a minimum height above 700 mm and below 960 mm.

WARNING



La macchina deve essere posta su un piano orizzontale.

WARNING



Do not obstruct the openings or slots for ventilation or heat dissipation and do not insert water or any kind of liquid.

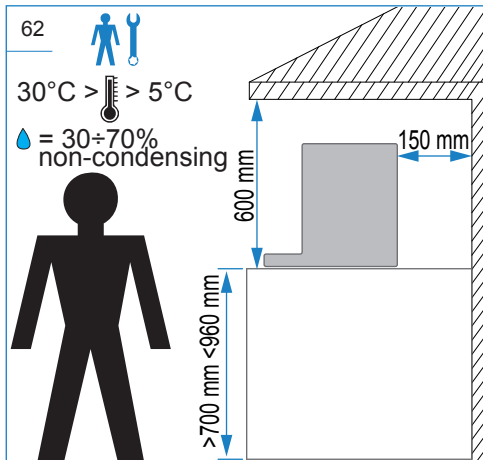

WARNING



In case of faults caused by the failure to follow the above, the Manufacturer declines any liability for damage caused by non-compliance with the aforesaid provisions.

WARNING

In case of prolonged storage at a temperature below 2°C, empty the machine hydraulic system. Do not switch the machine on before having reconditioned it for at least 1 hour at a suitable room temperature. If it is installed in areas with room temperature above 30°C, malfunctioning may occur.

8.4 INSTALLATION**8.4.1 Power mains connection****DANGER**

Do not carry out this operation with wet or damp hands.

63

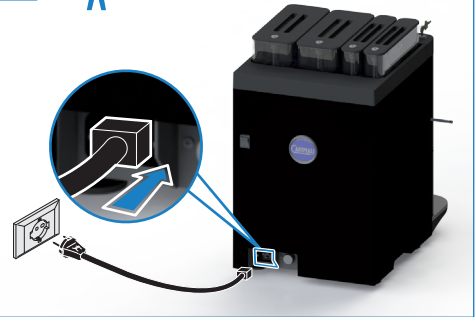
**NOTE**

Make sure the connector is properly inserted into the appropriate machine socket.

8.4.2 Water mains connection

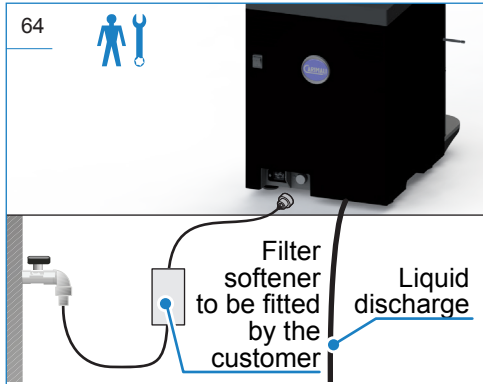

WARNING



For the proper use of the machine, install an external softener filter in case of water connection or use the apposite filter CARIMALI (with adapter, if required) on the machine equipped with tank.

WARNING



The connection to water mains must be done by a skilled technician in compliance with applicable regulations. Use the certified CARIMALI HOSE (95.01889). To prevent damages to the hydraulic circuit, the optimal range of the water inlet from the mains is between 10 and 15 French Degrees (60/80 Mg/l Ca).

8.4.3 Milk circuit connection

WARNING



Milk temperature must be below 4°C.

Connect the milk container to the Milker outlet hose.

65

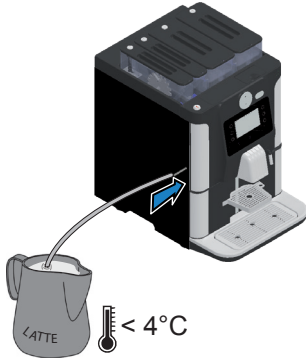

If an additional unit is fitted, connect the Milker outlet to the unit.

68

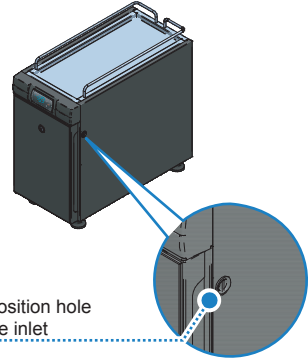

Predisposition hole
milk tube inlet

66



NOTE

The fridge was designed and built to work along with the machine BLUE-DOT, in order to ensure a correct conservation of milk at a suitable temperature.

For further details about the use and maintenance of the fridge, refer to the specific documentation.

67



9 INSTRUCTIONS FOR USE

9.1 GETTING STARTED

9.1.1 Water tank filling



- Open the lower door.

69



- Remove the water tank.

70



- Fill the tank.

71

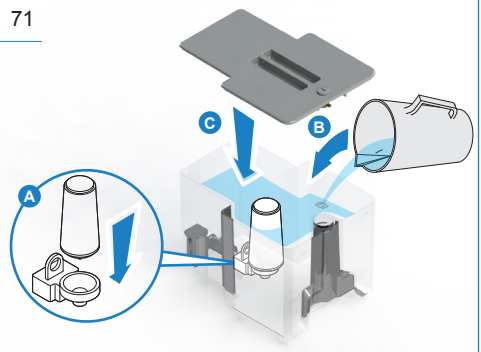

NOTE



Fill the tank up to the max. level.

NOTE



Always install the opposite filter CARIMALI (CariPure 100 Water Filter) into the tank. Once having inserted the adapter, always use the filter for the correct indication of empty tank.

NOTE



For more details on the CARIPURE 100 filter installation process, see the relevant section.

- Re-position the water tank.

72

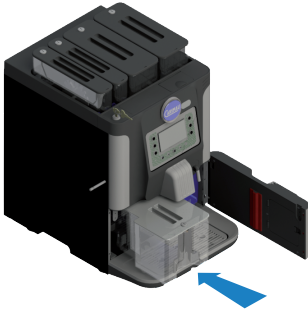

- Close the lower door.

73

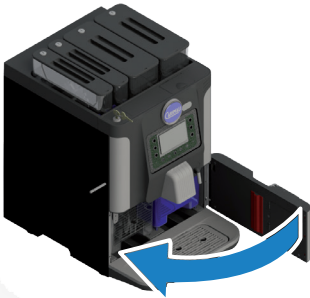

9.1.2 Product filling



- Open the required product container using the corresponding key.

74

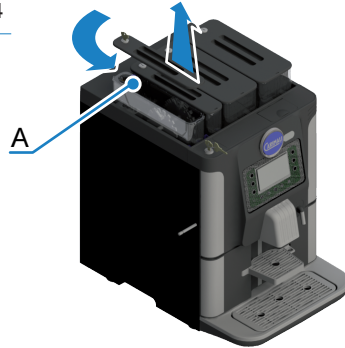

NOTE



Before pouring the product into the container, close the blue lock protection plug "A".

- Pour the required product into the container, avoiding to pour it onto the machine.

75

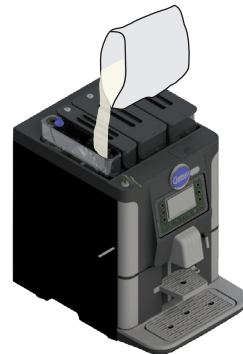

NOTE



Before closing the container, open the blue lock protection plug “A”.

- Close the container using the lock.

76



NOTE



Properly close the containers to prevent a machine stop.

NOTE



The process is valid, even if the optional raised containers are fitted.

9.2 SWITCHING ON



After having carried out the installation and the preliminary operations, proceed with machine switching on.

1. Press the switching on key.

77

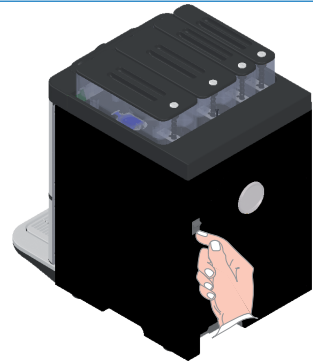

2. When the machine is on, the following screens appear.

78



Machine ON

3. Before the boiler reaches the temperature, it remains on hold on heating.

79

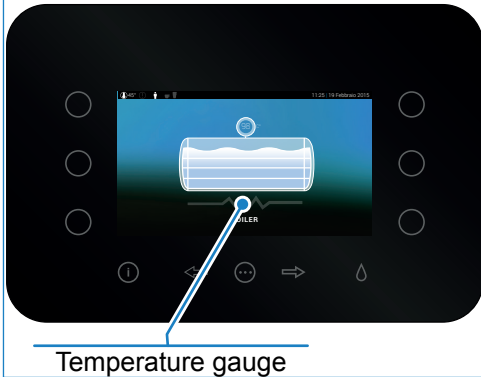

4. After the boiler heating, if the exchanger is present, the machine will heat it up.

80

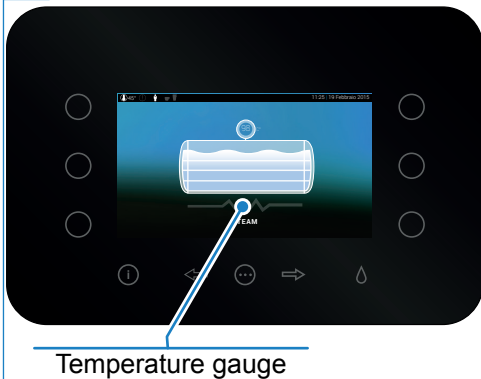

NOTE



Allow the machine to heat up before proceeding with drink dispensing.

9.3 DRINK DISPENSING



Once the machine reaches the working temperature, it is possible to proceed with drink dispensing. For dispensing, press the key corresponding to required drink.

NOTE



WATER SYSTEM FILLING:

When installing for the first time or after emptying, carry out the boiler filling procedure.

9.3.1 Boiler filling

This operation serves to fill the filter, the pump and the circuit of the boiler.

ATTENTION



By omitting this operation, the machine may be seriously damaged and the Manufacturer's liability on machine functioning shall lapse immediately.

1. With the first installation or every time the machine is emptied with the apposite procedure, press the “Boiler fill” key to fill the boiler.

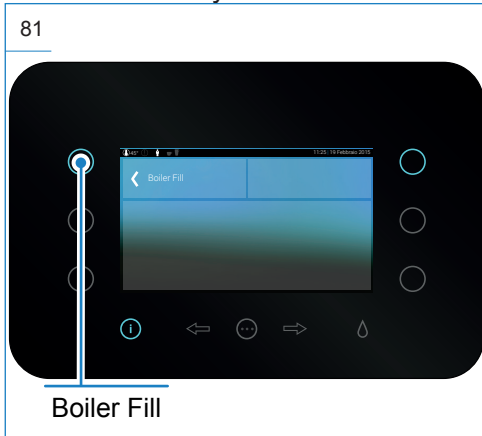

2. Await until boiler filling is completed.

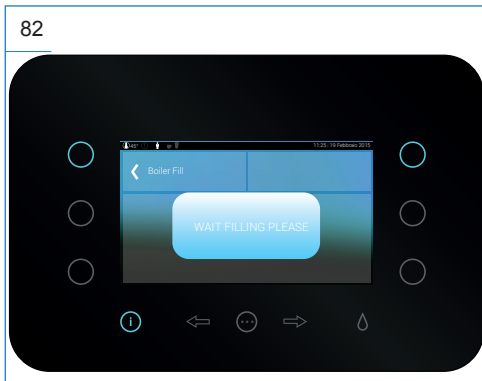

3. Once the procedure is completed, the screen “Power ON” appears.

9.3.2 Dispensing circuit washing

WARNING



When using the machine for the first time or when it is not used for a long period of time, carry out the washing of the dispensing circuit to avoid any impurity in the boiler or in the system.

83

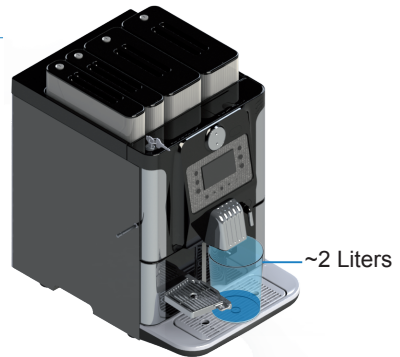

Use one of the following two alternative methods:

1. Dispense approx. 4-6 l of water, according to the versions, from:
 - Hot water spout (if fitted)
 - Water by-pass (if fitted)
 - Instant product dispensing nozzle without the presence of the products in the related containers.
2. Start a “All-in-one” washing (to be repeated twice or three times), which allows the execution of the circuit washing, including milker, in semi-automatic mode.

10 ROUTINE MAINTENANCE



DANGER

The intervention of routine maintenance and cleaning must be performed by the operator only after:

- having switched the machine off
- having disconnected the machine power supply, by unplugging it
- having closed the tap upstream of the water mains connection (if available on the machine version)
- having awaited the cooling time of the machine.

The operator must always use protective gloves to prevent abrasions.



WARNING



Do not pull the power cord or the machine itself to unplug the machine from the electric power socket.

WARNING



Each operation requiring disassembly of the machine parts must be performed by a skilled technician.

OPERATION	TYPE OF OPERATION	FREQUENCY	PARAGRAPH
TFT display cleaning	Manual	Daily	10.1.1
External cleaning of chrome-plated surfaces	Manual	Daily	10.1.2
External cleaning of machine surfaces	Manual	Daily	10.1.3
Emptying and cleaning the liquid grounds container	Manual	Daily or before if necessary	10.1.4
Emptying and cleaning the solid grounds container	Manual	When counting is reached	10.1.4
Instant product / coffee bean containers	Manual	Weekly	10.1.5
All in One cleaning	Semiautomatic (alternative to single semiautomatic procedured)	Daily	10.2.2
Espresso unit cleaning	Automatic (Light)	Several times during the day, if possible	10.2.4
	Semiautomatic	Daily	10.2.3
	Manual	Weekly	10.2.5
Fresh Brew group cleaning	Automatic (Light)	Several times during the day, if possible	10.2.4
	Semiautomatic	Daily	10.2.3
Mixer cleaning	Automatic	Daily	10.2.6
	Manual	Weekly or when necessary	10.2.7
Milker circuit cleaning	Semiautomatic	Daily	10.2.8
	Manual	Weekly or when necessary	10.2.9
Water tank cleaning	Manual	Weekly	/
Filter replacement	Manual	100 Litres of delivery	4.5.7 9.1.1
Outer softener filter (if present)	*	*	8.4.2

* See the relevant Manufacturer's instructions.

For cleaning the inner components, open the front door of the machine by using the keys supplied.

84



10.1 EXTERNAL CLEANING

10.1.1 TFT cleaning

85

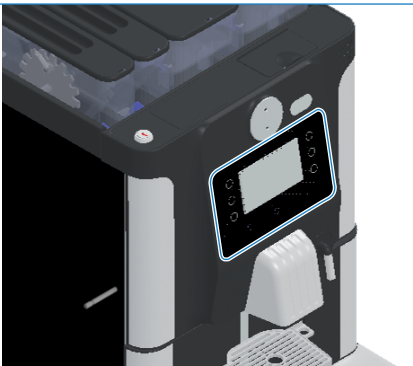

WARNING



Do not use alcohol, solvents or abrasive agents to carry out this operation.

10.1.2 Cleaning of chrome-plated surfaces

86

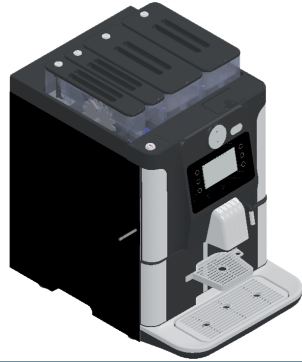

WARNING



For cleaning the chrome-plated surfaces, use a damp cloth, an antistatic cloth or similar. Do not use abrasive agents to carry out this operation.

10.1.3 Cleaning of machine surfaces

Proceed with the daily external cleaning of the machine using a cloth dampened with water and dry thoroughly.

WARNING



Do not use solvents, chlorine-based products or abrasive agents to carry out this operation. Do not clean the machine with direct water jets. Never immerse the machine in water or other liquids.

10.1.4 Cleaning of solid/liquid grounds container

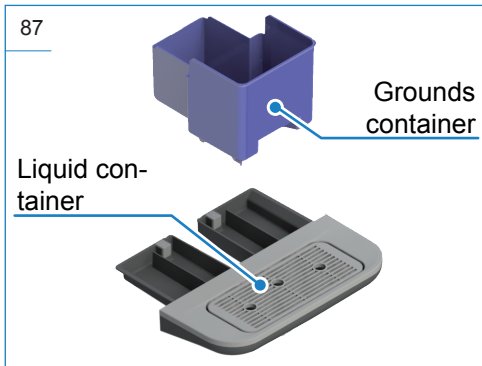

NOTE



Wash with care to prevent the proliferation of bacteria.

ATTENTION



When cleaning the grounds container, take care not to damage the grounds compactor group (optional).

10.1.5 Cleaning of instant products/ coffee bean containers

Carry out the following procedures for cleaning the containers of instant products and coffee beans:

- Open the upper front door.



- Remove the instant product containers from the machine.

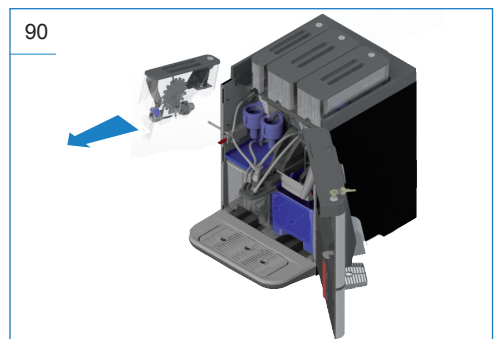
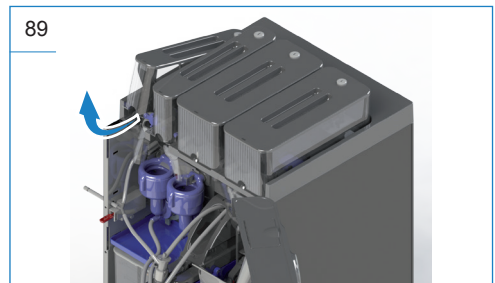

- Press the flap to close the side.

91 (view from the bottom up)



- Remove the coffee containers from the machine.

92

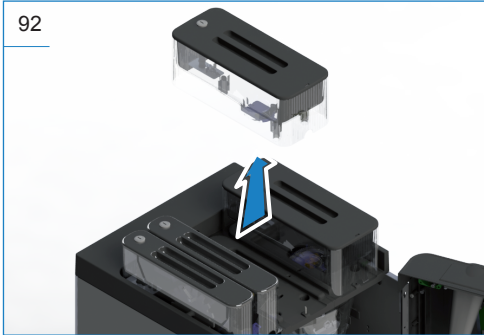

- Open the containers using the appropriate key.

93

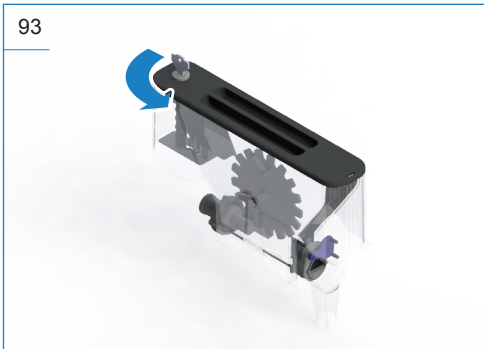

94

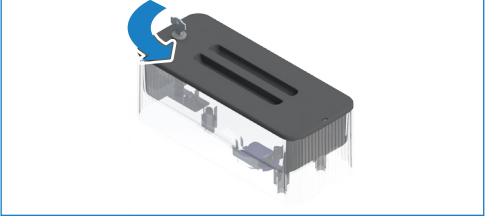

- Clean with hot water solution and sanitizing agents.
- Rinse and dry thoroughly.
- Insert the containers into the machine.

NOTE



In case the containers required by the configuration are missing or are not inserted properly, the machine stops working.

NOTE





The process is valid, even if the optional raised containers are fitted.

10.2 CLEANING OF FUNCTIONAL UNITS

10.2.1 Cleaning mode access

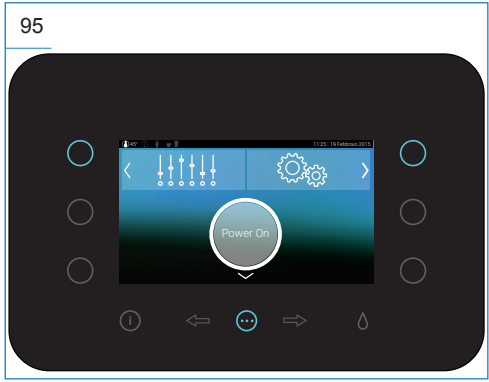
- From the Power ON screen press the key .



- Press the key .

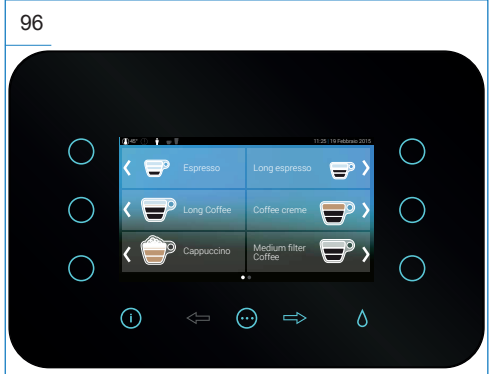

- Access the cleaning menu by pressing the key  corresponding to the "Cleaning" entry.

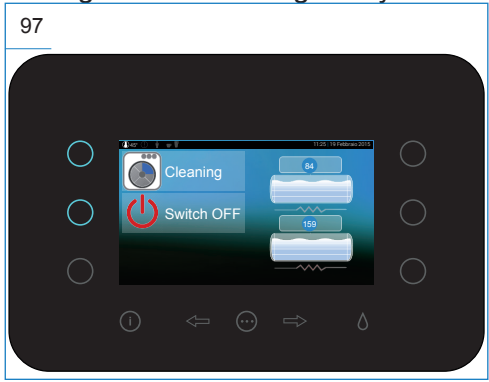

If enables, the machine can require washing for a group/circuit.

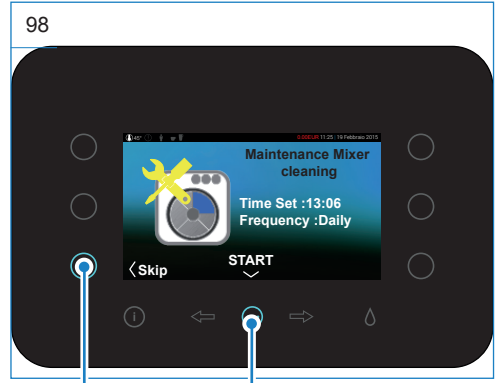

Press to postpone the wash

Press to proceed with washing.

NOTE



If the installation technician has enabled the Timer washing function, when the pre-set time is up, the machine will require it. This can be postponed, if necessary, once only. The Milker must be washed on a daily basis.

NOTE



The Skip function might not be enabled and as a result, not view the second machine configuration in the display.

10.2.2 All in one Wash

This type of wash makes it possible to carry out all possible washes according to the machine configuration and in the following sequence:

1. Milker wash;
2. Mixer wash;
3. Group wash.

NOTE



If the machine configuration does not contain a group or circuit, the wash will automatically pass to the group or the next circuit present.

NOTE



To carry out this procedure, follow the instructions on the display.

Before proceeding with an All in One wash, according to the machine layout:

- If there is a Milker circuit, insert the float in a container with water and Carimali sanitizer (06.00136). Follow the instructions on the sanitizer package for a proper dilution.
- Put a container of approx. 2 l under the dispensing nozzle to collect the cleaning liquids.

- In machines with tank (WT), fill the tank with water up to the MAX level.

99

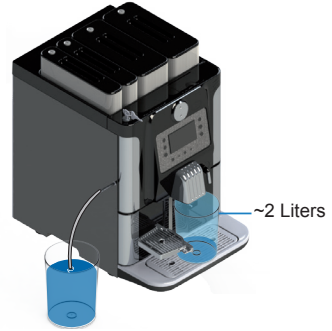

- From the cleaning menu, select "All in one".

100

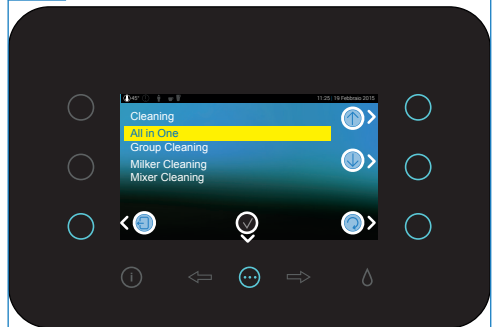

1. The display will require insertion of the washing tabs for the Espresso and Fresh Brew group, according to the machine configuration.

Press  to confirm.

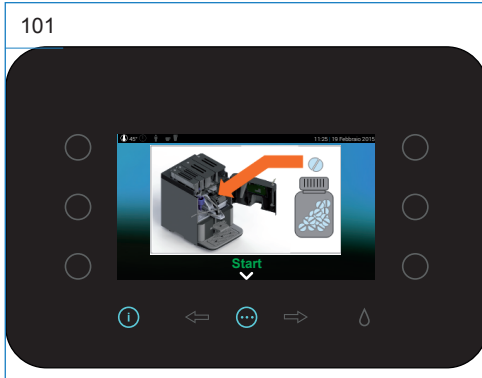

2. Open the front door of the machine and insert a CARIMALI tablet (06.00133) into the Espresso and/or Fresh Brew group, according to the machine configuration.

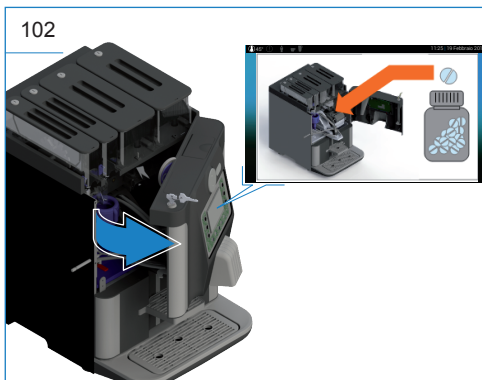

ATTENTION



In the machine version with tank (WT), check and fill the water tank up to the MAX level if necessary. It is absolutely necessary to ensure that there is enough water during the cleaning cycle.

NOTE



The selected group sets itself in position for tablet insertion.

3. Close the door and the machine will turn on automatically.

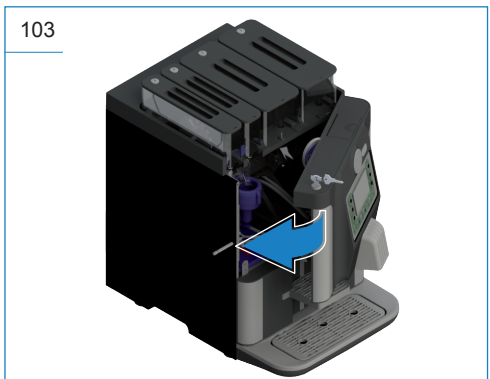

Press  to start the cleaning cycle.

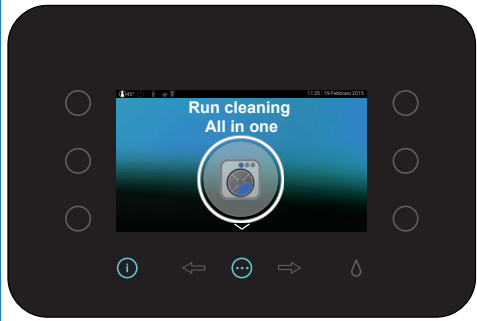

104

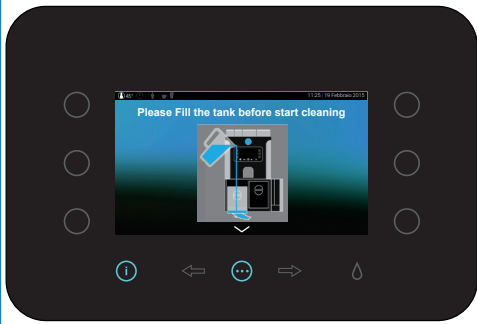

4. On machines with tank (WT), the display will show a reminder to fill the tank with water up to the MAX level. Press  to start the cleaning cycle.

105



- Press  (yes) to switch the machine back on from the beverage selection, once the wash cycle has been completed.
- Press  (yes) to switch the machine back on from the beverage selection, once the wash cycle has been completed.

16

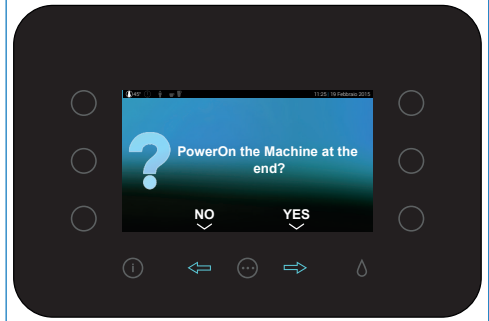

5. Connect the Milker circuit, if part of the machine configuration, to a container with water and CARIMALI sanitizer (06.00136).

107

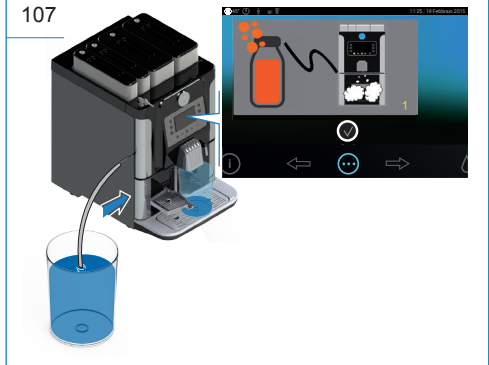

ATTENTION



Follow the instructions on the sanitizer package for a proper dilution.

- Clean the milk pipe.

108

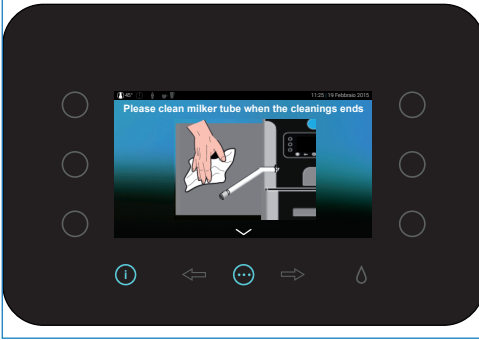

NOTE



The machine will automatically rinse the full milker circuit, extracting water from the tank or mains (according to configuration).

Press  to start the cleaning cycle. The machine will carry out the wash, showing the following screen.

109

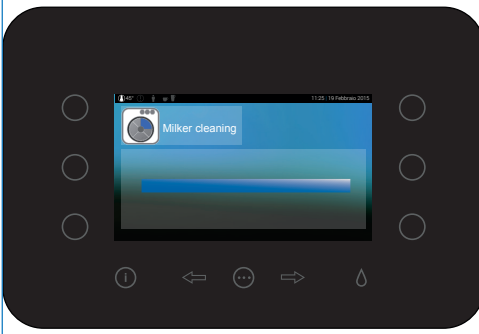

ATTENTION



Once the “All in One” washing cycle has been completed, remove the milk float (if present) from the container of water and sanitizer and rinse it carefully.

ATTENTION



Before proceeding with the normal use of the machine, carry out some test dispensing cycles.

10.2.3 Semi-automatic cleaning of the Espresso/ Fresh Brew units

NOTE



To carry out this procedure, follow the instructions on the display. The procedure is identical for both units.

- From the cleaning menu, select “Group Cleaning”.

110

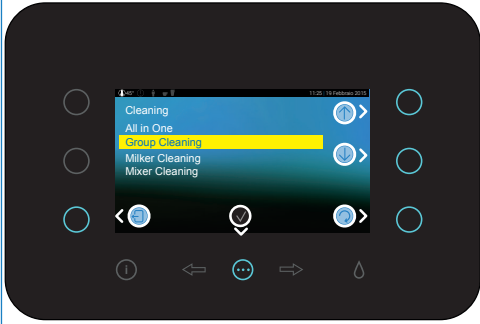

- Select “Semi-Automatic ES” to proceed with cleaning of the Espresso unit, or “Semi-Automatic FB” to carry out the cleaning of the Fresh Brew unit.

111

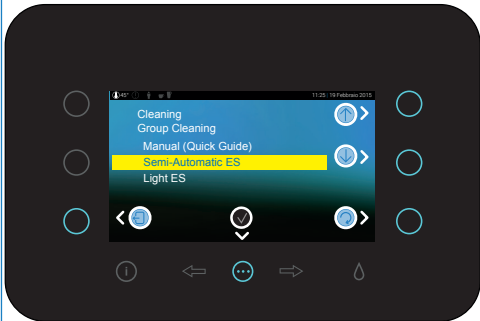

112

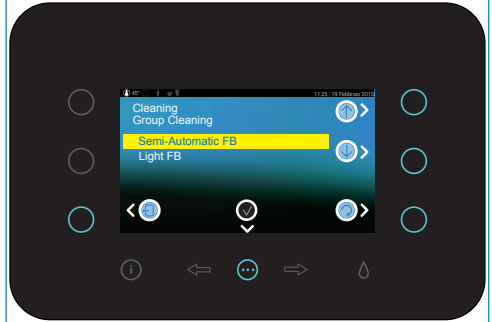

NOTE



The selected unit prepares in position for tablet insertion.

- Once having selected the cleaning mode, the following screen is displayed. Open the door and insert a CARIMALI tablet (6.00133) into the unit.

113

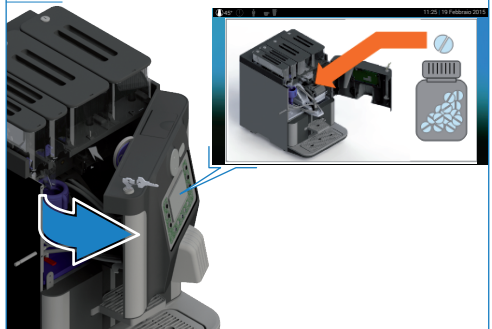

ATTENTION



In the machine version with tank (WT), check and fill the water tank up to the MAX level if necessary. It is absolutely necessary to ensure that there is enough water during the cleaning cycle.

- Close the door and the machine will turn on automatically. Press  to start the cleaning cycle.

114

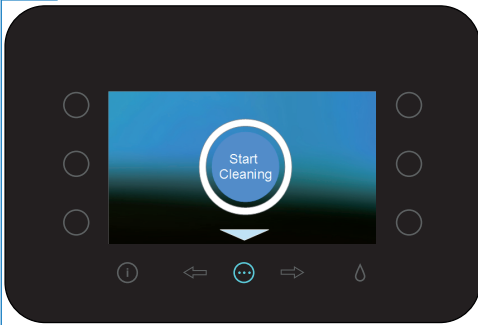

NOTE



The cycle lasts approx. 8 minutes. Put a container of approx. 2 l under the dispensing nozzle to collect the cleaning liquids.

NOTE



If the cleaning cycle is stopped suddenly before its completion, the unit returns to HOME screen and the machine carries out an automatic rinsing cycle.

To perform a complete cleaning cycle, always repeat the procedure from the beginning, verifying the rinsing is carried out.

NOTE



The cleaning procedures of the Espresso and Fresh Brew units cannot be performed at the same time.

ATTENTION



At the end of the cycle, the "Power ON" screen is shown. Before proceeding with the normal use of the machine, carry out some test dispensing cycles.

10.2.4 LIGHT cleaning of the Espresso/Fresh Brew units

NOTE



This type of washing does not require the use of tablets or the need of opening the machine. The only ingredient used for cleaning is hot water from the water distribution system/tank.

ATTENTION



In the machine version with tank (WT), check and fill the water tank up to the MAX level if necessary. It is absolutely necessary to ensure that there is enough water during the cleaning cycle.

NOTE



The procedure is identical for both units.

- From the cleaning menu, select “Group Cleaning”.

115

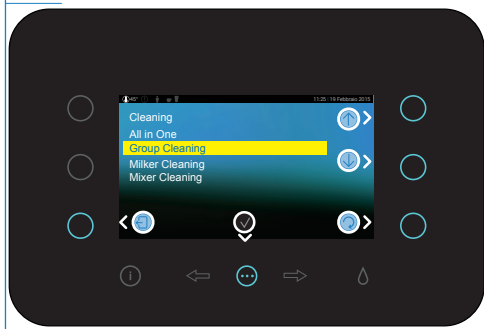

- Select “Light ES” to proceed with cleaning of the Espresso unit or “Light FB” to carry out the cleaning of the Fresh Brew unit.

116

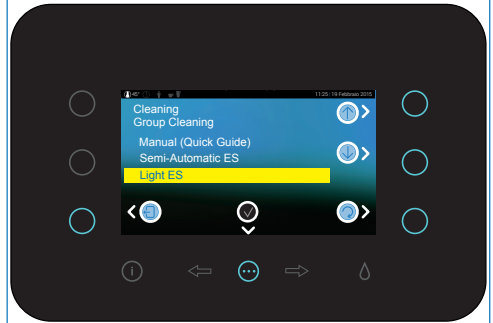

117

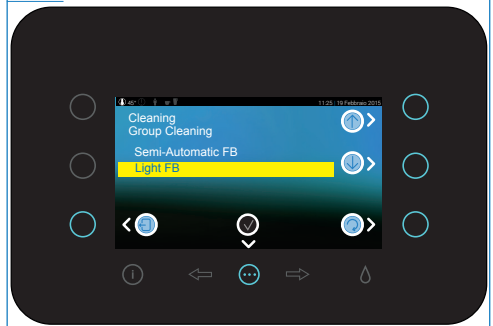

- Await until the cleaning of the selected unit is completed.

118

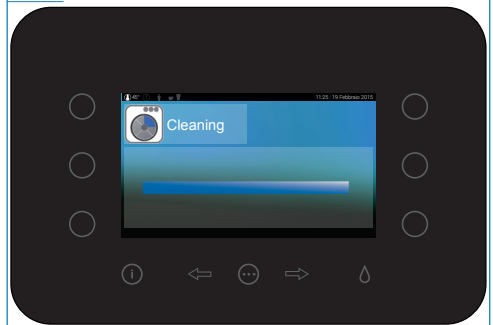

NOTE



The cleaning cycle lasts approximately 1 minute and uses 150 ml of water.

ATTENZIONE



At the end of the cycle, the cleaning menu is shown. Before proceeding with the normal use of the machine, carry out some test dispensing cycles.

10.2.5 Manual cleaning of the Espresso unit

NOTE



Carry out this procedure for a manual cleaning of the components or in case of complete / partial replacement of the Espresso unit.

NOTE



To carry out this procedure, follow the instructions on the display.

- From the cleaning menu, select “Group Cleaning”.

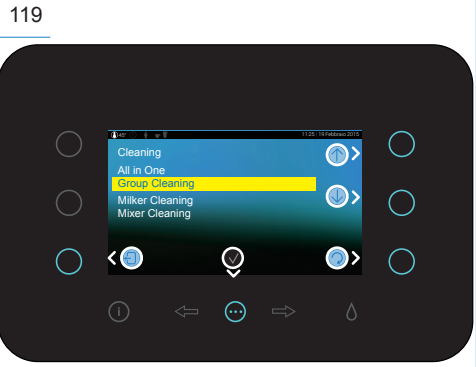

- Select the entry “Manual (Quick Guide)”.

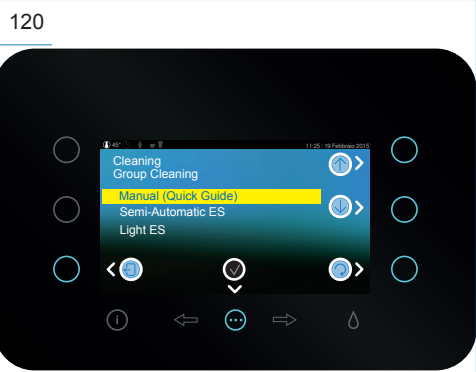

NOTE



The unit moves to the rest position.

- Open the front door.

121

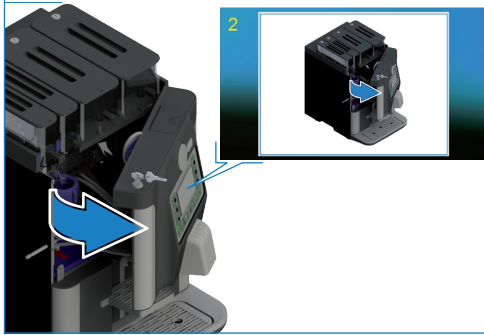

- Release the “A” fitting, pressing on the button, then slide out the pipe “B”.

122

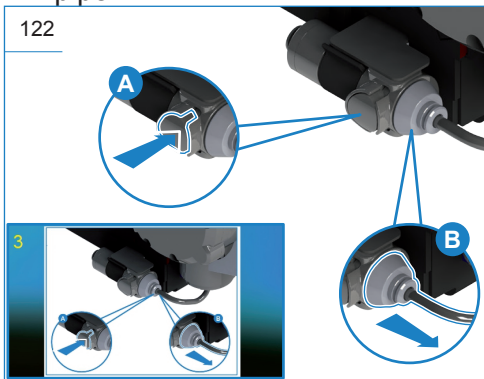

- Slide out the waste pipe “A” and press the lever “B” inwards to free the group.

123

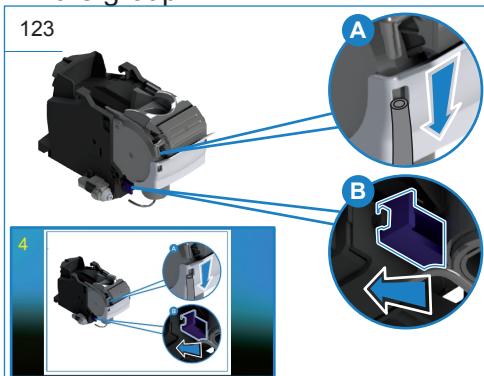

- Remove the unit towards the front side of the machine.

124

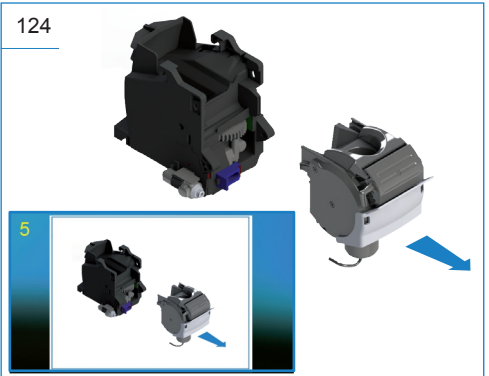

- Clean the Espresso unit with lukewarm water.

125



ATTENTION



Adjust the water temperature to prevent the risk of burn.

WARNING



If the water is too hot, the lubricant in the unit may be washed away.

WARNING



For cleaning the components, make sure the inner channels and edges are cleaned and rinsed.

Required tools for cleaning:

- CARIMALI brush (9.501.806)
- Lukewarm water

- Insert the brush into the Espresso unit and remove any residue.

126

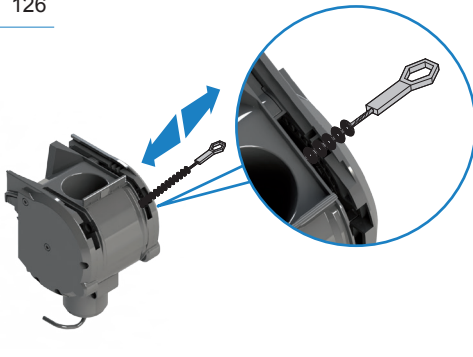

- Rinse the Espresso unit thoroughly using lukewarm water and manually rotate the gears.

127

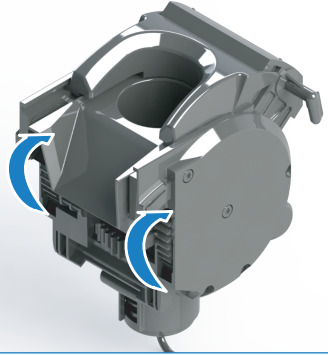

ATTENTION



Make sure the components are perfectly dry before installing them again on the machine, to prevent bacteria growth.

NOTE



Assemble the Espresso unit by proceeding in the reverse order compared to the above instructions.

NOTE



At the end of the cycle, the “Power ON” screen is shown.

10.2.6 Mixer automatic cleaning

NOTE



This procedure can be carried out following the instructions on the display.

ATTENTION



In the machine version with tank (WT), check and fill the water tank up to the MAX level if necessary. It is absolutely necessary to ensure that there is enough water during the cleaning cycle. The water consumption is approx. 1.5 l.

NOTE



Put a container of approx. 2 l under the dispensing nozzle.

- From the cleaning menu, select “Group Cleaning”.

128

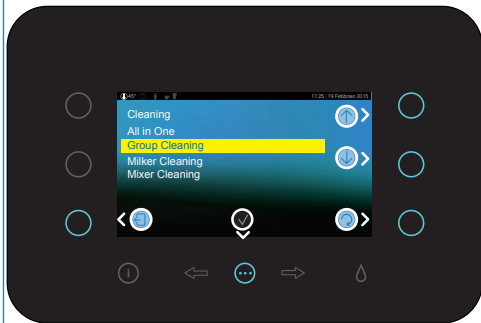

NOTE



The machine carries out the cleaning automatically.

- Await until the cleaning of the selected unit is completed.

129

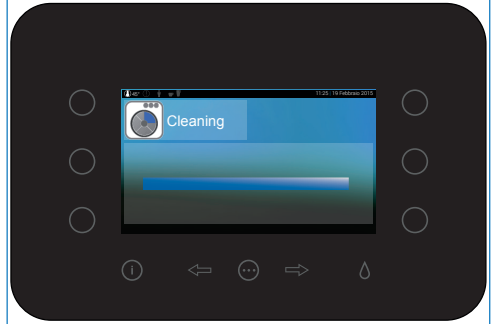

ATTENTION



At the end of the cycle, the cleaning menu is shown. Before proceeding with the normal use of the machine, carry out some test dispensing cycles.

10.2.7 Disassembly and manual cleaning of the instant products Mixer

ATTENTION



Open the upper front door of the machine and disconnect the hoses that might interfere with this procedure.

- Rotate the chute(s).

130

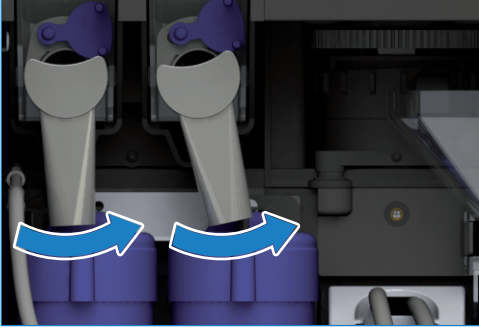

- Rotate the ring nut to match the flaps with the relevant slots and release the mixer.

131

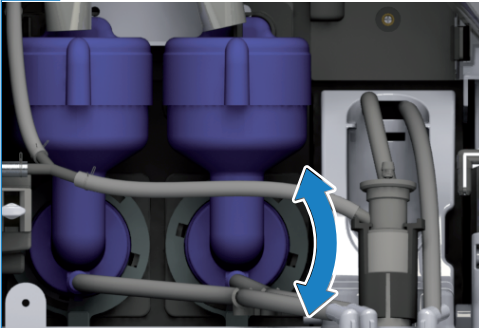

- Remove the mixer towards the front side of the machine.

132

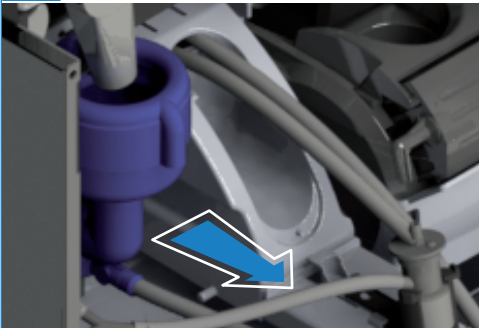

ATTENTION



Do not put in the dishwasher.

NOTE

For cleaning operations, use the CARIMALI cleaning agent (06.00136).



Required tools for cleaning:

- Hot water
- Cleaning agent
- Immerse all components in a solution of hot water and cleaning agent CARIMALI.

133

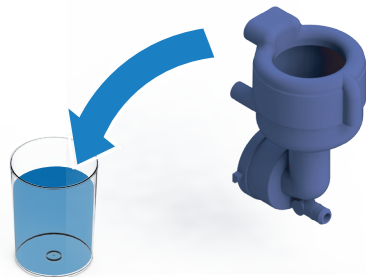

- Immerse all components in a solution of hot water and cleaning agent CARIMALI.

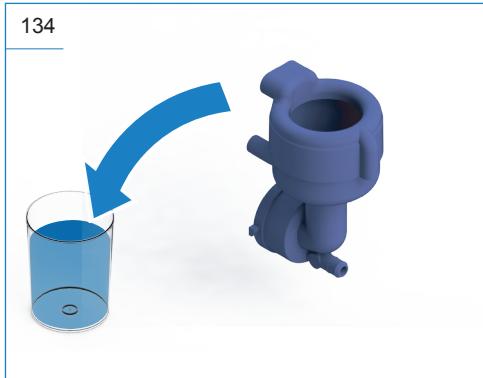

- Rinse all components with running hot water.

ATTENTION



Make sure the components are perfectly dry before installing them again on the machine, to prevent bacteria growth.

NOTE



Assemble the Mixer by proceeding in the reverse order compared to the above instructions.

10.2.8 Cleaning of Milker circuit

NOTE



This procedure can be carried out following the instructions on the display.

NOTE



Put a container of approx.ly 2 l under the dispensing nozzle to collect the cleaning liquids.

NOTE



Once having confirmed the cycle start, it cannot be cancelled.

ATTENTION



When using the Milker, carry out the procedure of semi-automatic cleaning at least once a day. If the use of Milker is very intense and / or the room temperature is high, it is recommended to increase the number of washings.

- From the cleaning menu, select “Milker Cleaning”.

135

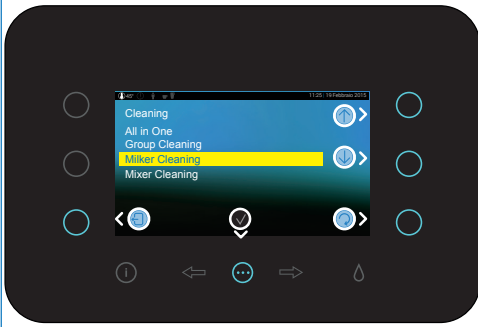

- Await until the Milker cleaning is completed.

137

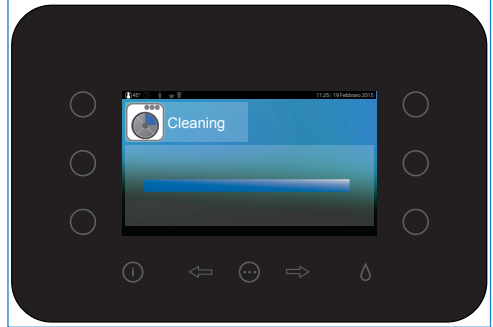

- Connect the Milker circuit to a container with water and CARIMALI sanitizer (06.00136). Follow the instructions on the sanitizer package for a proper dilution.

NOTE



For the complete rinsing of the Milker circuit, use more than 1 l of fresh water.

136

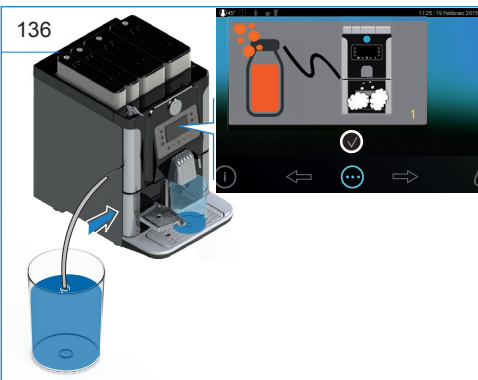

NOTE



Put a container of approx. 2 l under the dispensing nozzle.

- When shown on the display, connect the Milker circuit to a container with fresh water for rinsing.

138

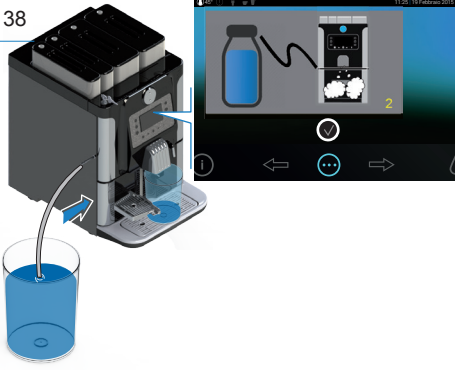

- Await until the Milker rinsing is completed.

139

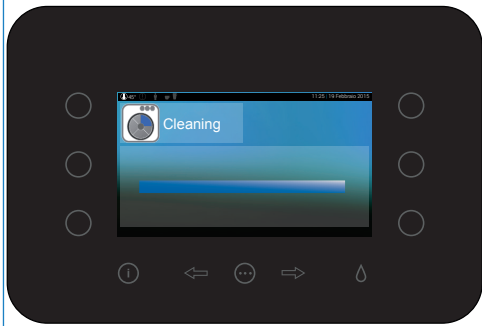

ATTENTION



If the cleaning cycle is stopped suddenly before its completion, always repeat the procedure from the beginning, making sure the rinsing phase is carried out.

ATTENTION



At the end of the cycle, the cleaning menu is shown. Before proceeding with the normal use of the machine, carry out some test dispensing cycles.

10.2.9 Disassembly and manual cleaning of Milker

ATTENTION



During the disassembly phase of the Milker, do not damage its components.

- Open the front door and remove the milk frother from its seat through the apposite locking flaps.

140

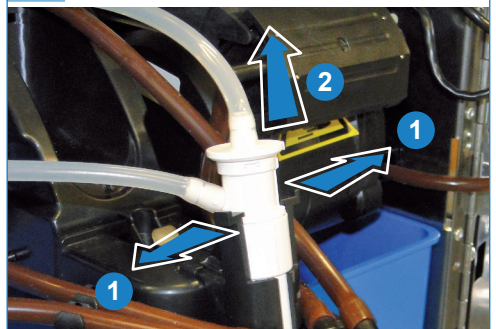

- Disconnect the connection hoses of the milk circuit.

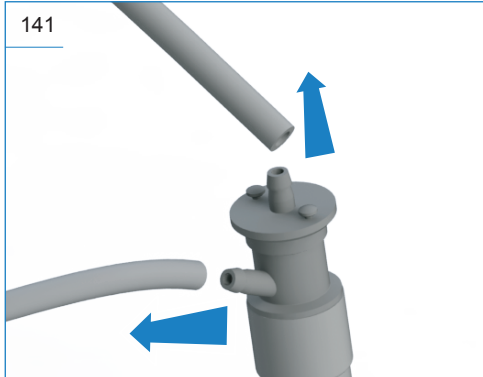

- Remove the milk frother.

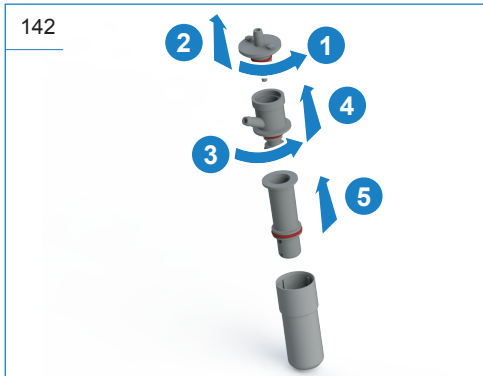

NOTE



Check the O-rings and replace them, if necessary.

NOTE



Assemble the Milker by proceeding in the reverse order compared to the above instructions.

ATTENTION



To prevent the risk of contamination of the dispensed drinks, carry out the cleaning procedure on a regular basis, following the instructions described in this manual.

NOTE



For cleaning operations, use the CARIMALI cleaning agent (06.00136).



Required tools for cleaning:

- Brush (CARIMALI 95.01806)
- Hot water
- Cleaning agent

NOTE



Washing components can also be carried out in the dishwasher.

- Immerse all components in a solution of hot water and cleaning agent CARIMALI.

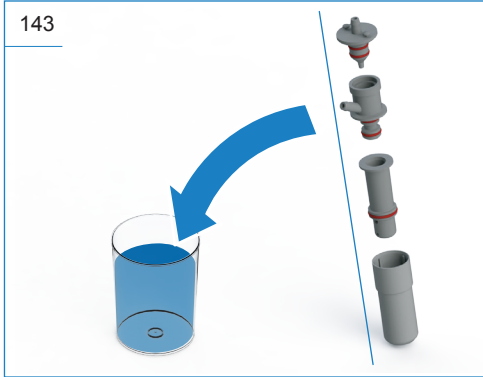

- Brush the Milker dispensing nozzle with the brush to remove the residues.

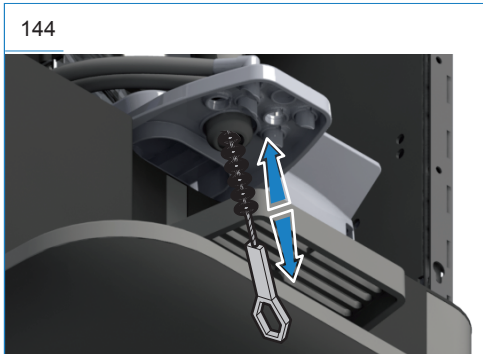

- Rinse all components with running hot water.





ATTENTION





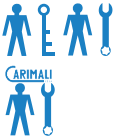
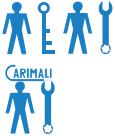

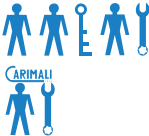
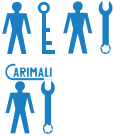
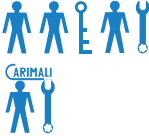
Make sure the components are perfectly dry before installing them again on the machine, to prevent bacteria growth.

- Re-assemble the Milker.

11 TROUBLESHOOTING







FAULT	POSSIBLE CAUSE	POSSIBLE SOLUTION	USER
The machine does not turn on. (TFT off)	Wrong connection to the power mains.	Check and repair wiring.	
	Faulty door safety micro switch.	Check micro switch.	
	General electric failure.	Contact the Service centre.	
Drinks dispensed incorrectly.	Obstructed dispensing nozzle/s.	Perform a cleaning cycle of the dispensing nozzle/s.	
Water leakage from the drip tray.	Drip tray full.	Empty the drip tray.	
Machine is on but does not dispense anything (block situation with alarm on the display).	Wrong closing of product containers.	Check and close well the product containers.	
	Grounds drawer not inserted.	Check and insert the drawer properly.	
	Fault of the Air Break, of the hydraulic connection or of the tank.	Contact the Service centre.	

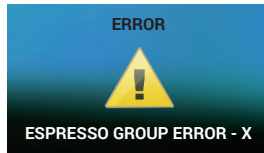

11.1 DEFINITION OF ERRORS AND ALARM LEVELS

SYMBOLS	LEVEL	DESCRIPTION
	High	Machine failure
	Medium-high	The problem can be solved and requires the switching off of the machine to restore the normal operation.
	Medium-low	The problem can be solved and does not require the switching off of the machine. The normal operation is restored by solving the problem.
	Low	Warning message for the operator.

11.2 ESPRESSO GROUP ERRORS







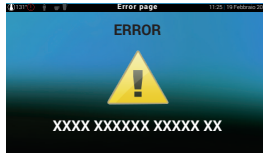

ERROR N°	POSSIBLE CAUSE	INTERVENTION	USER
2	Timeout piston motor waiting due to the delay in reaching the lower position.	Check motor.	
3	Timeout start position of the piston.	Check encoder.	
5	Timeout piston motor waiting due to the delay in reaching the start position.	Check motor.	
7	Timeout upper slider waiting due to the delay in reaching the closure position.	Check sensors. Check slider motor.	
8	Timeout upper slider waiting due to the delay in reaching the closure position.	Check slider motor.	
9	Timeout piston motor waiting due to the delay in reaching the upper position.	Check motor. Check encoder card.	
10 - 11	Timeout errors volumetric counting whilst dispensing: Error 10: Relative to the water impulses. Error 11: relative to the extra water impulses.	Check the volumetric counter.	

ERROR N°	POSSIBLE CAUSE	INTERVENTION	USER
12	Timeout upper slider waiting due to the delay in reaching the opening position.	Check sensors.	
16	Timeout piston motor waiting due to the delay in reaching the lower start position.	Check encoder card.	

11.3 FRESH BREW GROUP ERRORS



ERROR N°	POSSIBLE CAUSE	INTERVENTION	USER
1	Mechanical fault during the re-start procedure.	Open the upper front door. Check the Fresh Brew unit. Contact the Service centre, if necessary.	
2	0 position not detected by the sensor.	Open the upper front door. Check the Fresh Brew unit. Contact the Service centre, if necessary.	
3	The opening waiting time of the Fresh Brew unit has elapsed.	Open the upper front door. Check the Fresh Brew unit. Contact the Service centre, if necessary.	
4	The waiting time of half opening of the Fresh Brew unit has elapsed.	Open the upper front door. Check the Fresh Brew unit. Contact the Service centre, if necessary.	
5	The waiting time of the filter closing has elapsed.	Open the upper front door. Check the Fresh Brew unit. Contact the Service centre, if necessary.	
6	The waiting time of the filter opening has elapsed.	Open the upper front door. Check the Fresh Brew unit. Contact the Service centre, if necessary.	
7	The waiting time of the filter cleaning has elapsed.	Open the upper front door. Check the Fresh Brew unit. Contact the Service centre, if necessary.	

ERROR N°	POSSIBLE CAUSE	INTERVENTION	USER
8	The water waiting time has elapsed.	Open the upper front door. Check the Fresh Brew unit. Contact the Service centre, if necessary.	

11.4 STEAM ERRORS

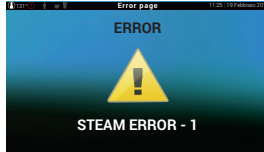

POSSIBLE CAUSE	INTERVENTION	USER
The heating waiting time has elapsed.	Switch the machine off. Access the inner parts. Check the heating element. Contact the Service centre, if necessary.	

11.5 ERRORS WATER ENTRY

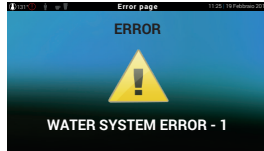

POSSIBLE CAUSE	INTERVENTION	USER
The waiting time of the hot water spout has elapsed.	Switch the machine off. Access the inner parts. Check the outer water circuit. Check the Air-Break filling. Contact the Service centre, if necessary.	

11.6 MISSING COFFEE ERRORS

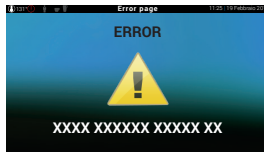

MESSAGE	POSSIBLE CAUSE	INTERVENTION	USER
MISSING COFFEE - 1	Missing coffee beans in container 1.	Insert the coffee beans in container 1. Re-start the machine.	

MESSAGE	POSSIBLE CAUSE	INTERVENTION	USER
MISSING COFFEE - 2	Missing coffee beans in container 2.	Insert the coffee beans in container 2. Re-start the machine.	
MISSING COFFEE - 4	Missing instant coffee.	Insert the decaf coffee. The alarm resets automatically after 15 seconds.	
MISSING DECA	A decaf drink was requested, but there are no products in the decaf compartment.	Insert the instant coffee into the apposite container. Re-start the machine.	

11.7 GSM ERRORS

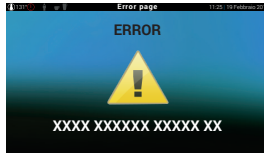

MESSAGE	POSSIBLE CAUSE	INTERVENTION	USER
SINCRONIZATION ERROR	The GSM module is not responding correctly to the request	Make sure that the module is connected correctly.	
NO ANSWER FROM MODULE	The GSM module is not responding	Make sure that the module is connected correctly.	
BAUD RATE ERROR	Settings error for GSM module communication.	Check communication settings for the GSM module	
TYPE ERROR	Settings error for GSM module communication.	Check communication settings for the GSM module	
NETWORK ERROR	No network connection	Move the GSM module so as to restore the connection.	
PIN ERROR	Incorrect PIN entered.	Check the PIN entered.	
SIGNAL QUALITY	Low quality signal (25%) or no network connection	Move the GSM module so as to restore the connection.	
SMS ERROR	SMS send error.	Make sure the connection signal is good quality.	

MESSAGE	POSSIBLE CAUSE	INTERVENTION	USER
PUK ERROR	The PIN has been incorrectly entered 3 times	Enter the correct PUK code for the SIM.	
MISSING SIM CARD	SIM card not found.	Insert the SIM card correctly in its slot on the GSM module.	

11.8 MDB ERRORS

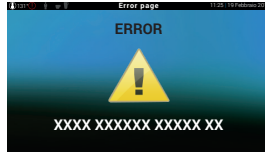

MESSAGE	POSSIBLE CAUSE	INTERVENTION	USER
NO ANSWER FROM MODULE	The MDB module is not responding correctly to the request.	Make sure that the module is connected correctly. Check the MDB module operating conditions.	
PAYMENT ERROR	The payment process is not successful.	The machine was unable to make payment. Check the credit or any other anomalies signalled by the connected MDB module.	
	The module is not able to deliver change (this can only be viewed if the machine is configured for this).	Refill the coins inside the tubes. Re-start the machine.	

11.9 HIGH-LEVEL GENERAL ERRORS

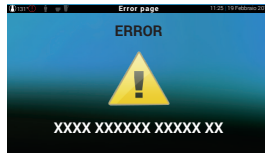

MESSAGE	POSSIBLE CAUSE	INTERVENTION	USER
BOILER TEMPERATURE HIGH	Fault of boiler heating at too high temperature.	Switch the machine off. Contact the Technical Support.	
BOILER NOT WORKING	Fault of boiler operation.	Switch the machine off. Contact the Technical Support.	

MESSAGE	POSSIBLE CAUSE	INTERVENTION	USER
BOILER SENSOR ERROR	Fault of boiler sensor.	Switch the machine off. Contact the Technical Support.	
VOLUMETRIC SENSOR	Fault of flowmeter.	Switch the machine off. Contact the Technical Support.	
STEAM TEMPERATURE HIGH	Fault of steam dispensing at too high temperature.	Switch the machine off. Contact the Technical Support.	
STEAM NOT WORKING	Steam dispensing operation fault.	Switch the machine off. Contact the Technical Support.	
STEAM SENSOR ERROR	Steam dispensing sensor fault.	Switch the machine off. Contact the Technical Support.	
WASH UNCOMPLETED	Wash uncompleted.	Open the upper front door. Close the upper front door. Complete the washing procedure. Contact the Service centre, if necessary.	
BOILER FILL UNCOMPLETED	Boiler filling uncompleted.	Switch the machine off. Contact the Technical Support.	
FIRST INSTALL UNCOMPLETED	Procedure of first installation uncompleted.	Switch the machine off. Contact the Technical Support.	
COMUNICATION	Failure of electronic communication.	Switch the machine off. Contact the Technical Support.	

11.10 MEDIUM-LOW LEVEL GENERAL ERRORS

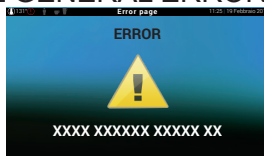

MESSAGE	POSSIBLE CAUSE	INTERVENTION	USER
INSERT LIQUID WASTE DRAWER	Liquid waste drawer not inserted or not inserted	Insert the drawer correctly.	
DRIP TRAY FULL	Drip tray full.	Remove the drip tray. Empty the drip tray. Re-insert the drip tray.	

MESSAGE	POSSIBLE CAUSE	INTERVENTION	USER
	Minimum level of water in the tank	Carry out the procedure shown on the display.	
	Minimum level of water in the tank	Await the water filling in the Air-Break.	
COFFEE GROUNDS DRAWER FULL	After approx. 25 deliveries from the Espresso group (75 with optional grounds compactor) and 35 from the Fresh Brew group.	Empty the drawer and wait at least 10 seconds before re-inserting it. Re-start the machine.	
COFFEE GROUNDS DRAWER FULL RESET FUNDS	After approx. 25 deliveries from the Espresso group (75 with optional grounds compactor) and 35 from the Fresh Brew group.	<div style="border: 1px solid black; padding: 5px; margin: 5px 0;">NOTE This message is visible only if the “Cup Station” option is enabled.</div> <p>Open the front door (the machine stops automatically). Empty the drawer, then close the front door (the machine starts automatically). Reset the counter by pressing when this message appears.</p>	
INSTANT X	Instant product containers not inserted or not inserted properly.	Insert the instant product container(s) properly.	
COFFEE HOPPER X	Coffee containers not inserted or not inserted properly.	Insert the coffee container(s) properly.	

12 DISPOSAL AND DECOMMISSIONING

This machine is compliant with the Directive 2012/19/EU.

WARNING



When the machine is not used any longer, render it inoperative after having unplugged it and having cut the power cord.

The disposal of the machine is not responsibility of the Manufacturer and must be carry out in compliance with the applicable regulations.

The Customer is held to:

- Disassemble the machine parts.
- Separate them according to material type.
- Deliver the material to the designated collection facilities.

WARNING



Follow the aforesaid disposal procedures, subject to penalties set forth in the applicable waste legislation.

Page intentionally left blank



Carimali S.p.A.

Via Industriale, 1

Chignolo d'Isola (BG)

24040 - ITALY

 +39 035 4949555

 +39 035 905447

 info@carimali.com

 carimali.com

